



# 201 TS

# THERMAL ARC INVERTER ARC WELDER



Art # A-10139

# Operating Manual

Revision: AB

Issue Date: May 20, 2011

Manual No.: 0-5149

Operating Features:



200  
AMP

CC

DC

110  
V

230  
V

1  
PHASE

50  
Hz  
60

INVERTER





## **WE APPRECIATE YOUR BUSINESS!**

Congratulations on your new Thermal Arc product. We are proud to have you as our customer and will strive to provide you with the best service and reliability in the industry. This product is backed by our extensive warranty and world-wide service network. To locate your nearest distributor or service agency call +44 (0) 1257 261 755, or visit us on the web at [www.Thermalarc.com](http://www.Thermalarc.com).

This Operating Manual has been designed to instruct you on the correct use and operation of your Thermal Arc product. Your satisfaction with this product and its safe operation is our ultimate concern. Therefore please take the time to read the entire manual, especially the Safety Precautions. They will help you to avoid potential hazards that may exist when working with this product. We have made every effort to provide you with accurate instructions, drawings, and photographs of the product(s) we used when writing this manual. However errors do occur and we apologize if there are any contained in this manual.

Due to our constant effort to bring you the best products, we may make an improvement that does not get reflected in the manual. If you are ever in doubt about what you see or read in this manual with the product you received, then check for a newer version of the manual on our website or contact our customer support for assistance.

## **YOU ARE IN GOOD COMPANY!**

### **The Brand of Choice for Contractors and Fabricators Worldwide.**

Thermal Arc is a Global Brand of Arc Welding Products for Thermadyne Industries Inc. We manufacture and supply to major welding industry sectors worldwide including; Manufacturing, Construction, Mining, Automotive, Aerospace, Engineering, Rural and DIY/Hobbyist.

We distinguish ourselves from our competition through market-leading, dependable products that have stood the test of time. We pride ourselves on technical innovation, competitive prices, excellent delivery, superior customer service and technical support, together with excellence in sales and marketing expertise.

Above all, we are committed to develop technologically advanced products to achieve a safer working environment within the welding industry.



## **WARNINGS**

---

*Read and understand this entire Manual and your employer's safety practices before installing, operating, or servicing the equipment.*

*While the information contained in this Manual represents the Manufacturer's best judgement, the Manufacturer assumes no liability for its use.*

---

Operating Manual Number 0-5149 for:

Thermal Arc 201 TS Power Source Arc Welder

Part Number W1003802

Thermal Arc 201 TS System with Stick/TIG Kit & Case

Part Number W1003803

Published by:

Thermadyne Industries, Inc.

82 Benning Street

West Lebanon, New Hampshire, USA 03784

(603) 298-5711

[www.thermadyne.com](http://www.thermadyne.com)

Copyright 2011 by

Thermadyne Industries, Inc.

All rights reserved.

Reproduction of this work, in whole or in part, without written permission of the publisher is prohibited.

The publisher does not assume and hereby disclaims any liability to any party for any loss or damage caused by any error or omission in this Manual, whether such error results from negligence, accident, or any other cause.

Publication Date: April 20, 2011

Revision AB date: May 20, 2011

### **Record the following information for Warranty purposes:**

Where Purchased: \_\_\_\_\_

Purchase Date: \_\_\_\_\_

Equipment Serial #: \_\_\_\_\_

## TABLE OF CONTENTS

### SECTION 1:

#### **ARC WELDING SAFETY INSTRUCTIONS AND WARNINGS ..... 1-1**

1.01	Arc Welding Hazards.....	1-1
1.02	Principal Safety Standards.....	1-5
1.03	Declaration Of Conformity .....	1-6

### SECTION 2:

#### **INTRODUCTION ..... 2-1**

2.01	How to Use This Manual.....	2-1
2.02	Equipment Identification.....	2-1
2.03	Receipt of Equipment.....	2-1
2.04	Transportation Methods.....	2-1
2.05	Symbol Chart.....	2-2
2.06	Description .....	2-3
2.07	User Responsibility.....	2-3
2.08	Duty Cycle.....	2-4
2.09	Specifications .....	2-5

### SECTION 3:

#### **INSTALLATION, OPERATION AND SETUP ..... 3-1**

3.01	Environment .....	3-1
3.02	Location.....	3-1
3.03	Electrical Input Connections .....	3-1
3.04	Electromagnetic Compatibility .....	3-3
3.05	Setup for Welding .....	3-4
3.06	STICK (MMA) Setup .....	3-5
3.07	LIFT TIG / HF TIG (GTAW) Setup.....	3-7
3.08	Leak Testing the System .....	3-8
3.09	When You Finish Using the Regulator.....	3-8
3.10	Storage of the Regulator.....	3-8

## TABLE OF CONTENTS

<b>SECTION 4:</b>		
<b>OPERATION</b>	.....	<b>4-1</b>
4.01	Front Panel .....	4-1
4.02	Welding Current Control Explanation .....	4-3
4.03	STICK (MMA) Electrode Polarity .....	4-3
4.04	Effects of Stick Welding Various Materials.....	4-3
4.05	GTAW Electrode Polarity .....	4-4
4.06	Guide for Selecting Filler Wire .....	4-4
4.07	Tungsten Electrode Current Ranges.....	4-4
4.08	Shielding Gas Selection .....	4-4
4.09	Tungsten Electrode Types .....	4-5
4.10	TIG Welding Parameters for Steel.....	4-5
4.11	Arc Welding Practice.....	4-5
4.12	Welding Position.....	4-6
4.13	Joint Preparations.....	4-7
4.14	Arc Welding Technique .....	4-8
4.15	The Welder.....	4-8
4.16	Striking the Arc .....	4-8
4.17	Arc Length .....	4-8
4.18	Rate of Travel .....	4-8
4.19	Making Welded Joints.....	4-9
4.20	Distortion.....	4-11
4.21	The Cause of Distortion .....	4-11
4.22	Overcoming Distortion Effects .....	4-12
<b>SECTION 5:</b>		
<b>SERVICE</b>	.....	<b>5-1</b>
5.01	Maintenance and Inspection .....	5-1
5.02	STICK (MMA) Welding Problems .....	5-2
5.03	TIG Welding Problems .....	5-3
5.04	Power Source Problems .....	5-4
<b>APPENDIX 1: OPTIONS AND ACCESSORIES</b>	.....	<b>A-1</b>
<b>APPENDIX 2: REPLACEMENT PARTS</b>	.....	<b>A-2</b>
<b>APPENDIX 3: 201 TS SYSTEM SCHEMATIC</b>	.....	<b>A-4</b>
<b>LIMITED WARRANTY &amp; WARRANTY SCHEDULE</b>		

## TABLE OF CONTENTS

### Thermal Arc 201 TS Stick/TIG System

#### Part Number W1003803

- Thermal Arc 201 TS power supply in toolbox
- 26 TIG torch, 3.8m (12.5ft) with Integrated Controls & accessory Kit
- Electrode holder, 5m (16.4ft)
- Work lead, 5m (16.4ft)
- 4 GP 3.2mm (1/8") dia stick electrodes
- Thermal Arc 201 TS Gas Hose lead 4m (13ft)
- Operating manual



Art # A-10140

## SECTION 1: ARC WELDING SAFETY INSTRUCTIONS AND WARNINGS



**WARNING**

**PROTECT YOURSELF AND OTHERS FROM POSSIBLE SERIOUS INJURY OR DEATH. KEEP CHILDREN AWAY. PACEMAKER WEARERS KEEP AWAY UNTIL CONSULTING YOUR DOCTOR. DO NOT LOSE THESE INSTRUCTIONS. READ OPERATING/INSTRUCTION MANUAL BEFORE INSTALLING, OPERATING OR SERVICING THIS EQUIPMENT.**

Welding products and welding processes can cause serious injury or death, or damage to other equipment or property, if the operator does not strictly observe all safety rules and take precautionary actions.

Safe practices have developed from past experience in the use of welding and cutting. These practices must be learned through study and training before using this equipment. Some of these practices apply to equipment connected to power lines; other practices apply to engine driven equipment. Anyone not having extensive training in welding and cutting practices should not attempt to weld.

Safe practices are outlined in the European Standard EN60974-1 entitled: Safety in welding and allied processes Part 2: Electrical. This publication and other guides to what you should learn before operating this equipment are listed at the end of these safety precautions. **HAVE ALL INSTALLATION, OPERATION, MAINTENANCE, AND REPAIR WORK PERFORMED ONLY BY QUALIFIED PEOPLE.**

### 1.01 ARC WELDING HAZARDS



**WARNING**

***ELECTRIC SHOCK can kill.***

*Touching live electrical parts can cause fatal shocks or severe burns. The electrode and work circuit is electrically live whenever the output is on. The input power circuit and machine internal circuits are also live when power is on. In semiautomatic or automatic wire welding, the wire, wire reel, drive roll housing, and all metal parts touching the welding wire are electrically live. Incorrectly installed or improperly grounded equipment is a hazard.*

1. Do not touch live electrical parts.
2. Wear dry, hole-free insulating gloves and body protection.
3. Insulate yourself from work and ground using dry insulating mats or covers.
4. Disconnect input power or stop engine before installing or servicing this equipment. Lock input power disconnect switch open, or remove line fuses so power cannot be turned on accidentally.
5. Properly install and ground this equipment according to its Owner's Manual and national, state, and local codes.
6. Turn off all equipment when not in use. Disconnect power to equipment if it will be left unattended or out of service.
7. Use fully insulated electrode holders. Never dip holder in water to cool it or lay it down on the ground or the work surface. Do not touch holders connected to two welding machines at the same time or touch other people with the holder or electrode.
8. Do not use worn, damaged, undersized, or poorly spliced cables.
9. Do not wrap cables around your body.
10. Ground the workpiece to a good electrical (earth) ground.
11. Do not touch electrode while in contact with the work (ground) circuit.
12. Use only well-maintained equipment. Repair or replace damaged parts at once.
13. In confined spaces or damp locations, do not use a welder with AC output unless it is equipped with a voltage reducer. Use equipment with DC output.
14. Wear a safety harness to prevent falling if working above floor level.
15. Keep all panels and covers securely in place.

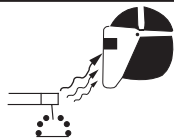

**WARNING**

*ARC RAYS can burn eyes and skin; NOISE can damage hearing.*

*Arc rays from the welding process produce intense heat and strong ultraviolet rays that can burn eyes and skin. Noise from some processes can damage hearing.*

1. Use a Welding Helmet or Welding Faceshield fitted with a proper shade of filter (see ANSI Z49.1 and EN 60974-1 listed in Safety Standards) to protect your face and eyes when welding or watching.
2. Wear approved safety glasses. Side shields recommended.
3. Use protective screens or barriers to protect others from flash and glare; warn others not to watch the arc.
4. Wear protective clothing made from durable, flame-resistant material (wool and leather) and foot protection.
5. Use approved ear plugs or ear muffs if noise level is high.
6. Never wear contact lenses while welding.



**WARNING**

*FUMES AND GASES can be hazardous to your health.*

*Welding produces fumes and gases. Breathing these fumes and gases can be hazardous to your health.*

1. Keep your head out of the fumes. Do not breathe the fumes.
2. If inside, ventilate the area and/or use exhaust at the arc to remove welding fumes and gases.
3. If ventilation is poor, use an approved air-supplied respirator.
4. Read the Material Safety Data Sheets (MSDSs) and the manufacturer's instruction for metals, consumables, coatings, and cleaners.
5. Work in a confined space only if it is well ventilated, or while wearing an air-supplied respirator. Shielding gases used for welding can displace air causing injury or death. Be sure the breathing air is safe.
6. Do not weld in locations near degreasing, cleaning, or spraying operations. The heat and rays of the arc can react with vapors to form highly toxic and irritating gases.

**Eye protection filter shade selector for welding or cutting (goggles or helmet), from AWS A6.2-73.**

Welding or Cutting Operation	Electrode Size Metal Thickness or Welding Current	Filter Shade No.	Welding or Cutting Operation	Electrode Size Metal Thickness or Welding Current	Filter Shade No.
Torch soldering		2	<b>Gas metal-arc welding (MIG)</b>		
Torch brazing		3 or 4	Non-ferrous base metal	All	11
Oxygen Cutting			Non-ferrous base metal	All	12
Light	Under 1 in., 25 mm	3 or 4	Gas tungsten arc welding	All	12
Medium	1 to 6 in., 25-150 mm	4 or 5	<b>(TIG)</b>	All	12
Heavy	Over 6 in., 150 mm	5 or 6	Atomic hydrogen welding	All	12
<b>Gas welding</b>			Carbon arc welding	All	12
Light	Under 1/8 in., 3 mm	4 or 5	Plasma arc welding		
Medium	1/8 to 1/2 in., 3-12 mm	5 or 6	<b>Carbon arc air gouging</b>		
Heavy	Over 1/2 in., 12 mm	6 or 8	Light		12
<b>Shielded metal-arc welding (stick) electrodes</b>	Under 5/32 in., 4 mm	10	Heavy		14
	5/32 to 1/4 in., 4 to 6.4 mm	12	<b>Plasma arc cutting</b>		
	Over 1/4 in., 6.4 mm	14	Light	Under 300 Amp	9
			Medium	300 to 400 Amp	12
			Heavy	Over 400 Amp	14



- Do not weld on coated metals, such as galvanized, lead, or cadmium plated steel, unless the coating is removed from the weld area, the area is well ventilated, and if necessary, while wearing an air-supplied respirator. The coatings and any metals containing these elements can give off toxic fumes if welded.

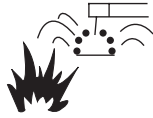

**WARNING**

*WELDING can cause fire or explosion.*

*Sparks and spatter fly off from the welding arc. The flying sparks and hot metal, weld spatter, hot workpiece, and hot equipment can cause fires and burns. Accidental contact of electrode or welding wire to metal objects can cause sparks, overheating, or fire.*

- Protect yourself and others from flying sparks and hot metal.
- Do not weld where flying sparks can strike flammable material.
- Remove all flammables within 10.7 m (35 ft) of the welding arc. If this is not possible, tightly cover them with approved covers.
- Be alert that welding sparks and hot materials from welding can easily go through small cracks and openings to adjacent areas.
- Watch for fire, and keep a fire extinguisher nearby.
- Be aware that welding on a ceiling, floor, bulkhead, or partition can cause fire on the hidden side.
- Do not weld on closed containers such as tanks or drums.
- Connect work cable to the work as close to the welding area as practical to prevent welding current from traveling long, possibly unknown paths and causing electric shock and fire hazards.
- Do not use welder to thaw frozen pipes.
- Remove stick electrode from holder or cut off welding wire at contact tip when not in use.



**WARNING**

*FLYING SPARKS AND HOT METAL can cause injury.*

*Chipping and grinding cause flying metal. As welds cool, they can throw off slag.*

- Wear approved face shield or safety goggles. Side shields recommended.
- Wear proper body protection to protect skin.



**WARNING**

*CYLINDERS can explode if damaged.*

*Shielding gas cylinders contain gas under high pressure. If damaged, a cylinder can explode. Since gas cylinders are normally part of the welding process, be sure to treat them carefully.*

- Protect compressed gas cylinders from excessive heat, mechanical shocks, and arcs.
- Install and secure cylinders in an upright position by chaining them to a stationary support or equipment cylinder rack to prevent falling or tipping.
- Keep cylinders away from any welding or other electrical circuits.
- Never allow a welding electrode to touch any cylinder.
- Use only correct shielding gas cylinders, regulators, hoses, and fittings designed for the specific application; maintain them and associated parts in good condition.
- Turn face away from valve outlet when opening cylinder valve.
- Keep protective cap in place over valve except when cylinder is in use or connected for use.
- Read and follow instructions on compressed gas cylinders, associated equipment, and CGA publication P-1 listed in Safety Standards.



**WARNING**

*Engines can be dangerous.*



**WARNING**

*ENGINE EXHAUST GASES can kill.*

Engines produce harmful exhaust gases.

- Use equipment outside in open, well-ventilated areas.
- If used in a closed area, vent engine exhaust outside and away from any building air intakes.

**WARNING**

*ENGINE FUEL can cause fire or explosion.*

*Engine fuel is highly flammable.*

1. Stop engine before checking or adding fuel.
2. Do not add fuel while smoking or if unit is near any sparks or open flames.
3. Allow engine to cool before fueling. If possible, check and add fuel to cold engine before beginning job.
4. Do not overfill tank — allow room for fuel to expand.
5. Do not spill fuel. If fuel is spilled, clean up before starting engine.

**WARNING**

*MOVING PARTS can cause injury.*

Moving parts, such as fans, rotors, and belts can cut fingers and hands and catch loose clothing.

1. Keep all doors, panels, covers, and guards closed and securely in place.
2. Stop engine before installing or connecting unit.
3. Have only qualified people remove guards or covers for maintenance and troubleshooting as necessary.
4. To prevent accidental starting during servicing, disconnect negative (-) battery cable from battery.
5. Keep hands, hair, loose clothing, and tools away from moving parts.
6. Reinstall panels or guards and close doors when servicing is finished and before starting engine.

**WARNING**

*SPARKS can cause BATTERY GASES TO EXPLODE; BATTERY ACID can burn eyes and skin.*

Batteries contain acid and generate explosive gases.

1. Always wear a face shield when working on a battery.
2. Stop engine before disconnecting or connecting battery cables.
3. Do not allow tools to cause sparks when working on a battery.

4. Do not use welder to charge batteries or jump start vehicles.
5. Observe correct polarity (+ and -) on batteries.

**WARNING**

*STEAM AND PRESSURIZED HOT COOLANT can burn face, eyes, and skin.*

*The coolant in the radiator can be very hot and under pressure.*

1. Do not remove radiator cap when engine is hot. Allow engine to cool.
2. Wear gloves and put a rag over cap area when removing cap.
3. Allow pressure to escape before completely removing cap.

**LEAD WARNING**

*This product contains chemicals, including lead, or otherwise produces chemicals known to the State of California to cause cancer, birth defects and other reproductive harm. Wash hands after handling. (California Health & Safety Code § 25249.5 et seq.)*

**WARNING**

*This product, when used for welding or cutting, produces fumes or gases which contain chemicals known to the State of California to cause birth defects and, in some cases, cancer. (California Health & Safety code Sec. 25249.5 et seq.)*

**NOTE**

*Considerations About Welding And The Effects of Low Frequency Electric and Magnetic Fields*

The following is a quotation from the General Conclusions Section of the U.S. Congress, Office of Tech-

nology Assessment, Biological Effects of Power Frequency Electric & Magnetic Fields - Background Paper, OTA-BP-E-63 (Washington, DC: U.S. Government Printing Office, May 1989): "...there is now a very large volume of scientific findings based on experiments at the cellular level and from studies with animals and people which clearly establish that low frequency magnetic fields and interact with, and produce changes in, biological systems. While most of this work is of very high quality, the results are complex. Current scientific understanding does not yet allow us to interpret the evidence in a single coherent framework. Even more frustrating, it does not yet allow us to draw definite conclusions about questions of possible risk or to offer clear science-based advice on strategies to minimize or avoid potential risks."

To reduce magnetic fields in the workplace, use the following procedures.

1. Keep cables close together by twisting or taping them.
2. Arrange cables to one side and away from the operator.
3. Do not coil or drape cable around the body.
4. Keep welding power source and cables as far away from body as practical.

**ABOUT PACEMAKERS:**

---

*The above procedures are among those also normally recommended for pacemaker wearers. Consult your doctor for complete information.*

---

**1.02 PRINCIPAL SAFETY STANDARDS**

Safety in Welding and Cutting, ANSI Standard Z49.1, from American Welding Society, 550 N.W. LeJeune Rd., Miami, FL 33126.

Safety and Health Standards, OSHA 29 CFR 1910, from Superintendent of Documents, U.S. Government Printing Office, Washington, D.C. 20402.

Recommended Safe Practices for the Preparation for Welding and Cutting of Containers That Have Held Hazardous Substances, American Welding Society Standard AWS F4.1, from American Welding Society, 550 N.W. LeJeune Rd., Miami, FL 33126.

National Electrical Code, NFPA Standard 70, from National Fire Protection Association, Batterymarch Park, Quincy, MA 02269.

Safe Handling of Compressed Gases in Cylinders, CGA Pamphlet P-1, from Compressed Gas Association, 1235 Jefferson Davis Highway, Suite 501, Arlington, VA 22202.

Code for Safety in Welding and Cutting, CSA Standard W117.2, from Canadian Standards Association, Standards Sales, 178 Rexdale Boulevard, Rexdale, Ontario, Canada M9W 1R3.

Safe Practices for Occupation and Educational Eye and Face Protection, ANSI Standard Z87.1, from American National Standards Institute, 1430 Broadway, New York, NY 10018.

Cutting and Welding Processes, NFPA Standard 51B, from National Fire Protection Association, Batterymarch Park, Quincy, MA 02269.

Safety in welding and allied processes Part 1: Fire Precautions, EN 60974-1 from SAI Global Limited, [www.saiglobal.com](http://www.saiglobal.com).

Safety in welding and allied processes Part 2: Electrical, EN 60974-1 from SAI Global Limited, [www.saiglobal.com](http://www.saiglobal.com).

Filters for eye protectors - Filters for protection against radiation generated in welding and allied operations AS/NZS 1338.1:1992 from SAI Global Limited, [www.saiglobal.com](http://www.saiglobal.com).

**1.03 DECLARATION OF CONFORMITY**

Manufacturer: Thermadyne Corporation  
Address: 82 Benning Street  
West Lebanon, New Hampshire 03784  
USA



The equipment described in this manual conforms to all applicable aspects and regulations of the 'Low Voltage Directive' (European Council Directive 73/23/EEC as amended by Council Directive 93/68/EEC) and to the National legislation for the enforcement of this Directive.

The equipment described in this manual conforms to all applicable aspects and regulations of the "EMC Directive" (European Council Directive 89/336/EEC) and to the National legislation for the enforcement of this Directive.

Serial numbers are unique with each individual piece of equipment and details description, parts used to manufacture a unit and date of manufacture.

**National Standard and Technical Specifications**

The product is designed and manufactured to a number of standards and technical requirements. Among them are:

- GENELEC EN50199 EMC Product Standard for Arc Welding Equipment.
- ISO/IEC 60974-1 (BS 638-PT10) (EN 60974-1) (EN50192) (EN50078) applicable to welding equipment and associated accessories.
- For environments with increased hazard of electrical shock, Power Supplies bearing the S mark conform to EN50192 when used in conjunction with hand torches with exposed cutting tips, if equipped with properly installed standoff guides.
- Extensive product design verification is conducted at the manufacturing facility as part of the routine design and manufacturing process. This is to ensure the product is safe, when used according to instructions in this manual and related industry standards, and performs as specified. Rigorous testing is incorporated into the manufacturing process to ensure the manufactured product meets or exceeds all design specifications.

**WARNING**

---

*This equipment does not comply with IEC 61000-3-12. If it is connected to a public low voltage system, it is the responsibility of the installer or user of the equipment to ensure, by consultation with the distribution network operator if necessary, that the equipment may be connected.*

---

Thermadyne has been manufacturing products for more than 30 years, and will continue to achieve excellence in our area of manufacture.

Manufacturers responsible representative:

Steve Ward  
Operations Director  
Thermadyne Europe  
Europa Building  
Chorley N Industrial Park  
Chorley, Lancashire,  
England PR6 7BX

## SECTION 2: INTRODUCTION

### 2.01 How to Use This Manual

This Manual usually applies to the part numbers listed on page i. To ensure safe operation, read the entire manual, including the chapter on safety instructions and warnings. Throughout this manual, the word WARNING, CAUTION and NOTE may appear. Pay particular attention to the information provided under these headings. These special annotations are easily recognized as follows:



#### **WARNING**

*Gives information regarding possible personal injury. Warnings will be enclosed in a box such as this.*



#### **CAUTION**

*Refers to possible equipment damage. Cautions will be shown in bold type.*

#### **NOTE**

*Offers helpful information concerning certain operating procedures. Notes will be shown in italics*

You will also notice icons from the safety section appearing throughout the manual. These are to advise you of specific types of hazards or cautions related to the portion of information that follows. Some may have multiple hazards that apply and would look something like this:



### 2.02 Equipment Identification

The unit's identification number (specification or part number), model, and serial number usually appear on a nameplate attached to the machine. Equipment which does not have a nameplate attached to the machine is identified only by the specification or part number printed on the shipping container. Record these numbers for future reference.

### 2.03 Receipt of Equipment

When you receive the equipment, check it against the invoice to make sure it is complete and inspect the equipment for possible damage due to shipping. If there is any damage, notify the carrier immediately to file a claim. Furnish complete information concerning damage claims or shipping errors to the location in your area listed in the inside back cover of this manual. Include all equipment identification numbers as described above along with a full description of the parts in error.

### 2.04 Transportation Methods



Disconnect input power conductors from de-energized supply line before moving the welding power source.

Lift unit with handle on top of case. Use handcart or similar device of adequate capacity. If using a fork lift vehicle, secure the unit on a proper skid before transporting.

**2.05 Symbol Chart**

Note that only some of these symbols will appear on your model.

	On
	Off
	Dangerous Voltage
	Increase/Decrease
	Circuit Breaker
	AC Auxiliary Power
	Fuse
<b>A</b>	Amperage
<b>V</b>	Voltage
<b>Hz</b>	Hertz (cycles/sec)
<b>f</b>	Frequency
<b>-</b>	Negative
<b>+</b>	Positive
	Direct Current (DC)
	Protective Earth (Ground)
	Line
	Line Connection
	Auxiliary Power
<b>115V 15A</b> 	Receptacle Rating-Auxiliary Power

<b>1</b>	Single Phase
<b>3</b>	Three Phase
	Three Phase Static Frequency Converter-Transformer-Rectifier
	Remote
<b>X</b>	Duty Cycle
<b>%</b>	Percentage
	Panel/Local
	Shielded Metal Arc Welding (SMAW)
	Gas Metal Arc Welding (GMAW)
	Gas Tungsten Arc Welding (GTAW)
	Air Carbon Arc Cutting (CAC-A)
	Constant Current
	Constant Voltage Or Constant Potential
	High Temperature
	Fault Indication
	Arc Force
	Touch Start (GTAW)
	Variable Inductance
	Voltage Input

	Wire Feed Function
	Wire Feed Towards Workpiece With Output Voltage Off.
	Welding Gun
	Purging Of Gas
	Continuous Weld Mode
	Spot Weld Mode
	Spot Time
	Prewflow Time
	Postflow Time
	2 Step Trigger Operation Press to initiate wirefeed and welding, release to stop.
	4 Step Trigger Operation Press and hold for preflow, release to start arc. Press to stop arc, and hold for preflow.
	Burnback Time
	Disturbance In Ground System
<b>IPM</b>	Inches Per Minute
<b>MPM</b>	Meters Per Minute

**2.06 Description**

This compact inverter welding machine has infinitely adjustable welding current from 10 to 200 amps. The 201TS has a LIFT TIG (GTAW) and HF TIG (GTAW) welding mode that offers stable TIG welding characteristics with an optimized start TIG sequence to initiate the welding arc when used with a suitable TIG torch and shielding gas. Advanced TIG features include 8 Pin Amp Plug for remote control devices, down slope, 2T / 4T controls, and gas solenoid operation. It also has STICK (MMA) welding mode which uses standard general purpose STICK (MMA) 2.5mm (3/32") electrodes for light gauge work, generally less than 3.2mm (1/8") thick and STICK (MMA) 3.2mm (1/8") electrodes for heavier material.

**2.07 User Responsibility**

This equipment will perform as per the information contained herein when installed, operated, maintained and repaired in accordance with the instructions provided. This equipment must be checked periodically. Defective equipment (including welding leads) should not be used. Parts that are broken, missing, plainly worn, distorted or contaminated, should be replaced immediately. Should such repairs or replacements become necessary, it is recommended that such repairs be carried out by appropriately qualified persons approved by Thermal Arc. Advice in this regard can be obtained by contacting an Accredited Thermal Arc Distributor.

This equipment or any of its parts should not be altered from standard specification without prior written approval of Thermal Arc. The user of this equipment shall have the sole responsibility for any malfunction which results from improper use or unauthorized modification from standard specification, faulty maintenance, damage or improper repair by anyone other than appropriately qualified persons approved by Thermal Arc.

**2.08 Duty Cycle**

The rated duty cycle of a Welding Power Source, is a statement of the time it may be operated at its rated welding current output without exceeding the temperature limits of the insulation of the component parts. To explain the 10 minute duty cycle period the following example is used. Suppose a Welding Power Source is designed to operate at a 20% duty cycle, 200 amperes at 18 volts. This means that it has been designed and built to provide the rated amperage (200A) for 2 minutes, i.e. arc welding time, out of every 10 minute period (20% of 10 minutes is 2 minutes). During the other 8 minutes of the 10 minute period the Welding Power Source must idle and be allowed to cool.

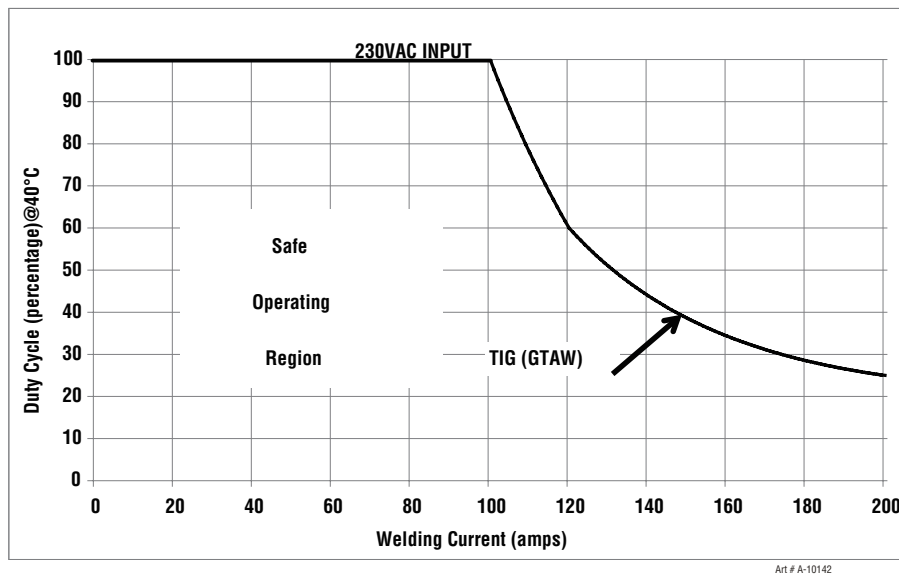
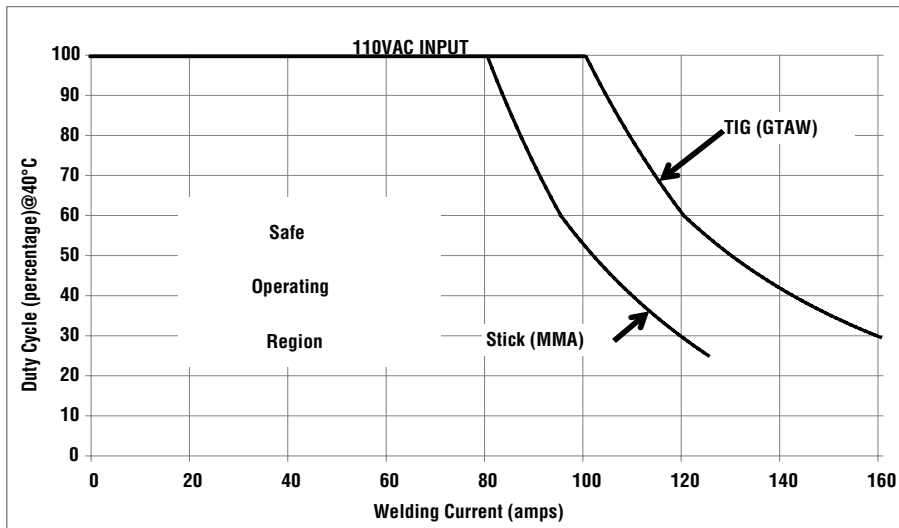

Figure 2-1: Thermal Arc 201 TS Duty Cycle



**2.09 Specifications**

Power Source Part Number	W1003802	
Mains Power		
Nominal Supply Voltage	AC 110V	AC 230V
Number of Phases	Single Phase	Single Phase
Input Voltage Range	AC 104- 127V	AC 187- 253V
Nominal Supply Frequency	50/60 Hz	50/60 Hz
Effective Input Current (I <sub>1 eff</sub> )	20 Amps	16 Amps
Maximum Input Current (I <sub>1 max</sub> )	Δ 39 Amps	Δ 32 Amps
Single Phase Generator Requirements [Continuous rating at nominal supply voltage with maximum output for STICK (MMA) welding]	5 KVA	8 KVA
Welding Output		
Welding Current Range	Stick: 10 - 125 Amps TIG: 10 - 160 Amps	Stick/TIG: 10 - 200 Amps
Nominal DC Open Circuit Voltage (OCV)	71V	71V
Welding Output, 104° F (40° C), 10 min. (Quoted figures refer to STICK (MMA) output)	125A @ 25%, 25.0V 95A @ 60%, 23.8V 80A @ 100%, 23.2V	200A @ 20%, 28V 120A @ 60%, 24.8V 100A @ 100%, 24.0V
Rated Input Current (A) for STICK (MMA) Welding	39A I <sub>o</sub> = 125A @ 25.0V	32A I <sub>o</sub> = 200A @ 28V
Rated Input Current (A) for LIFT TIG/HF TIG (GTAW) Welding	30A I <sub>o</sub> = 160A @ 16.4V	20.6A I <sub>o</sub> = 200A @ 18V
Rated Output for STICK (MMA) Welding	25.0V, 125A @ 25%	28V, 200A @ 20%
Rated Output for LIFT TIG/HF TIG (GTAW) Welding	16.4V, 160A @ 30%	18V, 200A @ 25%
Duty Cycle (%)	25% @ 125A	20% @ 200A
Welder Type	Inverter Power Source	
Output Terminal Type	Heavy Duty Dinse™ 50	
Classification		
Protection Class	IP23S	
Standards	EN 60974-1 EN50199	
Cooling Method	Fan Cooled	
Dimensions and Weight		
Welding Power Source Mass	10 kg (22 lb.)	
Welding Power Source Dimensions (Height x Width x Depth)	H230mm x W135mm x D450mm ( H 9.0" x W 5.3" x D 17.7")	

Δ The recommended time delay fuse or circuit breaker size is 32 amp for 110V and 32 amp for 230V.

*Thermal Arc continuously strives to produce the best product possible and therefore reserves the right to change, improve or revise the specifications or design of this or any product without prior notice. Such updates or changes do not entitle the buyer of equipment previously sold or shipped to the corresponding changes, updates, improvements or replacement of such items.*

*The values specified in the table above are optimal values, your values may differ. Individual equipment may differ from the above specifications due to in part, but not exclusively, to any one or more of the following; variations or changes in manufactured components, installation location and conditions and local power grid supply conditions.*

---

**NOTE**

---

*Due to variations that can occur in manufactured products, claimed performance, voltages, ratings, all capacities, measurements, dimensions and weights quoted are approximate only. Achievable capacities and ratings in use and operation will depend upon correct installation, use, applications, maintenance and service.*

**SECTION 3:  
INSTALLATION, OPERATION AND SETUP**

**3.01 ENVIRONMENT**

These units are designed for use in environments with increased hazard of electric shock. Examples of environments with increased hazard of electric shock are:

- A. In locations in which freedom of movement is restricted, so that the operator is forced to perform the work in a cramped (kneeling, sitting or lying) position with physical contact with conductive parts.
- B. In locations which are fully or partially limited by conductive elements, and in which there is a high risk of unavoidable or accidental contact by the operator.
- C. In wet or damp hot locations where humidity or perspiration considerable reduces the skin resistance of the human body and the insulation properties of accessories.

Environments with increased hazard of electric shock do not include places where electrically conductive parts in the near vicinity of the operator, which can cause increased hazard, have been insulated.

**3.02 LOCATION**

Be sure to locate the welder according to the following guidelines:

- A. In areas, free from moisture and dust.
- B. Ambient temperature between 0° C to 40° C.
- C. In areas, free from oil, steam and corrosive gases.
- D. In areas, not subjected to abnormal vibration or shock.
- E. In areas, not exposed to direct sunlight or rain.
- F. Place at a distance of 300mm or more from walls or similar that could restrict natural air flow for cooling.
- G. The enclosure design of this power source meets the requirements of IP23S as outlined in EN 60529. This provides adequate protection against solid objects (greater than 12mm), and direct protection from vertical drops. Under no circumstances should the unit be operated or connected in a micro environment that will exceed the stated conditions. For further information please refer to EN 60529.

- H. Precautions must be taken against the power source toppling over. The power source must be located on a suitable horizontal surface in the upright position when in use.



**WARNING**

*Thermal Arc advises that this equipment be electrically connected by a qualified electrician.*

**3.03 ELECTRICAL INPUT CONNECTIONS**



**WARNING**

*ELECTRIC SHOCK can kill; SIGNIFICANT DC VOLTAGE is present after removal of input power.*

**DO NOT TOUCH** live electrical parts.

**SHUT DOWN** welding power source, disconnect input power employing lockout/tagging procedures. Lockout/tagging procedures consist of padlocking line disconnect switch in open position, removing fuses from fuse box, or shutting off and red-tagging circuit breaker or other disconnecting device.

**• Electrical Input Requirements**

Operate the welding power source from a single-phase 50/60 Hz, AC power supply. The input voltage must match one of the electrical input voltages shown on the input data label on the unit nameplate. Contact the local electric utility for information about the type of electrical service available, how proper connections should be made, and inspection required. The line disconnect switch provides a safe and convenient means to completely remove all electrical power from the welding power supply whenever necessary to inspect or service the unit.

**Do not** connect an input (BROWN or BLUE) conductor to the ground terminal.

**Do not** connect the ground (GREEN or GREEN/YELLOW) conductor to an input line terminal.

Refer to Figure 3-1:

1. Connect end of ground (GREEN or GREEN/YELLOW) conductor to a suitable ground. Use a grounding method that complies with all applicable electrical codes.

2. Connect ends of line Active (BROWN) and Neutral (BLUE) input conductors to a suitable power supply system that complies with all applicable local electrical codes.
3. Use Table 3-1 as a guide to select line fuses for the disconnect switch.

Input Voltage	Circuit Breaker or Fuse Size
110V	32A
230V	32A

Table 3-1: Fuse Guide



**CAUTION**

*The time-delay fuses or circuit breaker of an individual branch circuit may have nuisance tripping when welding with this product due to the amperage rating of the time-delay fuses or circuit breaker.*

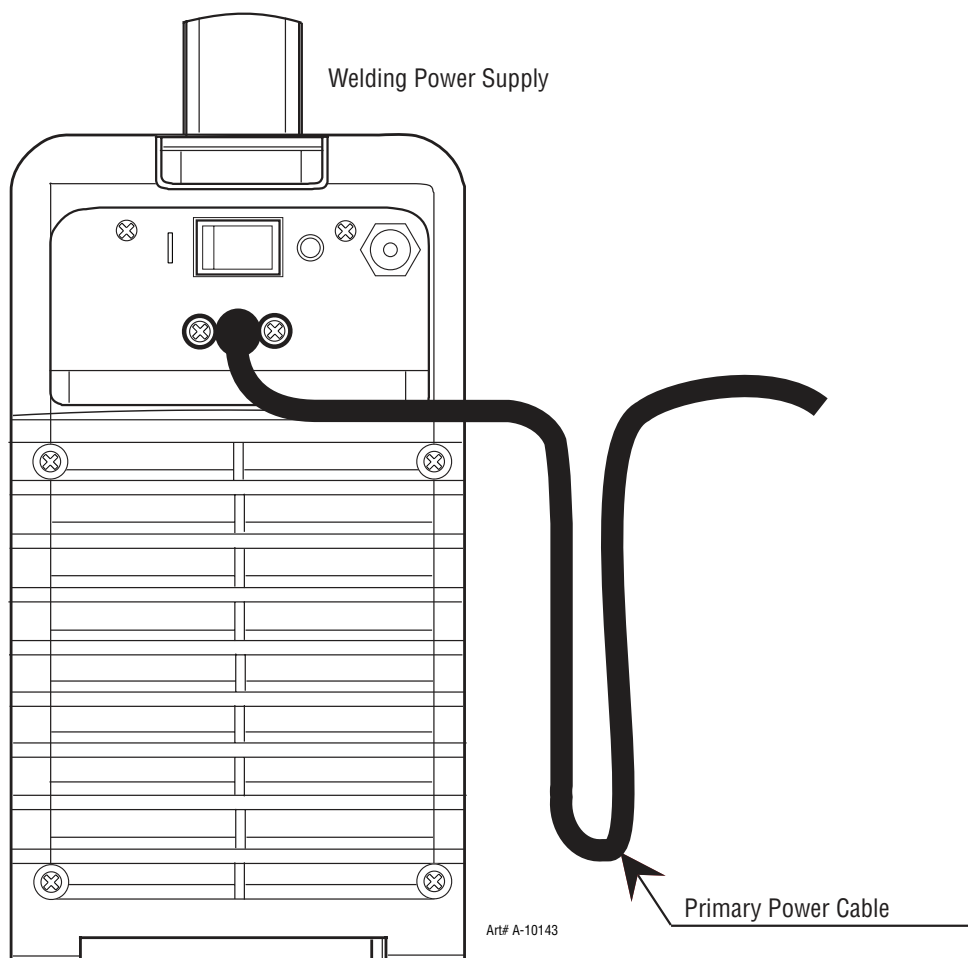

Figure 3-1 Electrical Input Connections

**Input Power**

Each unit incorporates an INRUSH circuit. When the MAIN CIRCUIT SWITCH is turned on, the inrush circuit provides pre-charging for the input capacitors. A relay in the Power Control Assembly (PCA) will turn on after the input capacitors have charged to operating voltage (after approximately 5 seconds)

**NOTE**

*Damage to the PCA could occur if 265 VAC or higher is applied to the Primary Power Cable.*

Model	Primary Supply Lead Size (Factory Fitted)	Minimum Primary Current Circuit Size (Vin/Amps)	Current & Duty Cycle	
			LIFT TIG/HF TIG (GTAW)	STICK (MMA)
Thermal Arc 201 TS	H07RN-F 2.5mm <sup>2</sup>	110V/39A	-	125A @ 25%
		110V/30A	160A @ 30%	-
		230V/32A	-	200A @ 25%
		230V/21A	200A @ 25%	-

Table 3-2: Primary Circuit Sizes to Achieve Maximum Current

**3.04 ELECTROMAGNETIC COMPATIBILITY**



**WARNING**

*Extra precautions for Electromagnetic Compatibility may be required when this Welding Power Source is used in a domestic situation.*

**A. Installation and Use - Users Responsibility**

The user is responsible for installing and using the welding equipment according to the manufacturer’s instructions. If electromagnetic disturbances are detected then it shall be the responsibility of the user of the welding equipment to resolve the situation with the technical assistance of the manufacturer. In some cases this remedial action may be as simple as earthing the welding circuit, see NOTE below. In other cases it could involve constructing an electromagnetic screen enclosing the Welding Power Source and the work, complete with associated input filters. In all cases, electromagnetic disturbances shall be reduced to the point where they are no longer troublesome.

**NOTE**

*The welding circuit may or may not be earthed for safety reasons. Changing the earthing arrangements should only be authorised by a person who is competent to assess whether the changes will increase the risk of injury, e.g. by allowing parallel welding current return paths which may damage the earth circuits of other equipment. Further guidance is given in IEC 60974-13 Arc Welding Equipment - Installation and use (under preparation).*

**B. Assessment of Area**

Before installing welding equipment, the user shall make an assessment of potential electromagnetic problems in the surrounding area. The following shall be taken into account

1. Other supply cables, control cables, signalling and telephone cables; above, below and adjacent to the welding equipment.
2. Radio and television transmitters and receivers.
3. Computer and other control equipment.
4. Safety critical equipment, e.g. guarding of industrial equipment.
5. The health of people around, e.g. the use of pacemakers and hearing aids.
6. Equipment used for calibration and measurement.
7. The time of day that welding or other activities are to be carried out.
8. The immunity of other equipment in the environment: the user shall ensure that other equipment being used in the environment is compatible: this may require additional protection measures.

The size of the surrounding area to be considered will depend on the structure of the building and other activities that are taking place. The surrounding area may extend beyond the boundaries of the premises.

### **C. Methods of Reducing Electromagnetic Emissions**

#### **1. Mains Supply**

Welding equipment should be connected to the mains supply according to the manufacturer's recommendations. If interference occurs, it may be necessary to take additional precautions such as filtering of the mains supply. Consideration should be given to shielding the supply cable of permanently installed welding equipment in metallic conduit or equivalent. Shielding should be electrically continuous throughout its length. The shielding should be connected to the Welding Power Source so that good electrical contact is maintained between the conduit and the Welding Power Source enclosure.

#### **2. Maintenance of Welding Equipment**

The welding equipment should be routinely maintained according to the manufacturer's recommendations. All access and service doors and covers should be closed and properly fastened when the welding equipment is in operation. The welding equipment should not be modified in any way except for those changes and adjustments covered in the manufacturer's instructions. In particular, the spark gaps of arc striking and stabilising devices should be adjusted and maintained according to the manufacturer's recommendations.

#### **3. Welding Cables**

The welding cables should be kept as short as possible and should be positioned close together, running at or close to the floor level.

#### **4. Equipotential Bonding**

Bonding of all metallic components in the welding installation and adjacent to it should be considered. However, metallic components bonded to the work piece will increase the risk that the operator could receive a shock by touching the metallic components and the electrode at the same time. The operator should be insulated from all such bonded metallic components.

#### **5. Earthing of the Workpiece**

Where the workpiece is not bonded to earth for electrical safety, nor connected to earth because of its size and position, e.g. ship's hull or building steelwork, a connection bonding the workpiece to earth may reduce emissions in some, but not all instances. Care should be taken to prevent the earthing of the workpiece increasing the risk of injury to users, or damage to other electrical equipment. Where necessary, the connection of the workpiece to earth should be made by direct connection to the workpiece, but in some countries where direct connection is not permitted, the bonding should be achieved by suitable capacitance, selected according to national regulations.

#### **6. Screening and Shielding**

Selective screening and shielding of other cables and equipment in the surrounding area may alleviate problems of interference. Screening the entire welding installation may be considered for special applications.

## **3.05 SETUP FOR WELDING**

### **NOTE**

*Conventional operating procedures apply when using the Welding Power Source, i.e. connect work lead directly to work piece and electrode lead is used to hold electrode. Wide safety margins provided by the design ensure that the Welding Power Source will withstand short-term overload without adverse effects. The welding current range values should be used as a guide only. Current delivered to the arc is dependent on the welding arc voltage, and as welding arc voltage varies between different classes of electrodes, welding current at any one setting would vary according to the type of electrode in use. The operator should use the welding current range values as a guide then fine tune the welding current to suit the application.*



**WARNING**

*Before connecting the work clamp to the work and inserting the electrode in the electrode holder make sure the Primary power supply is switched off.*



**CAUTION**

*Remove any packaging material prior to use. Do not block the air vents at the front or rear of the Welding Power Source.*

**3.06 STICK (MMA) SETUP**

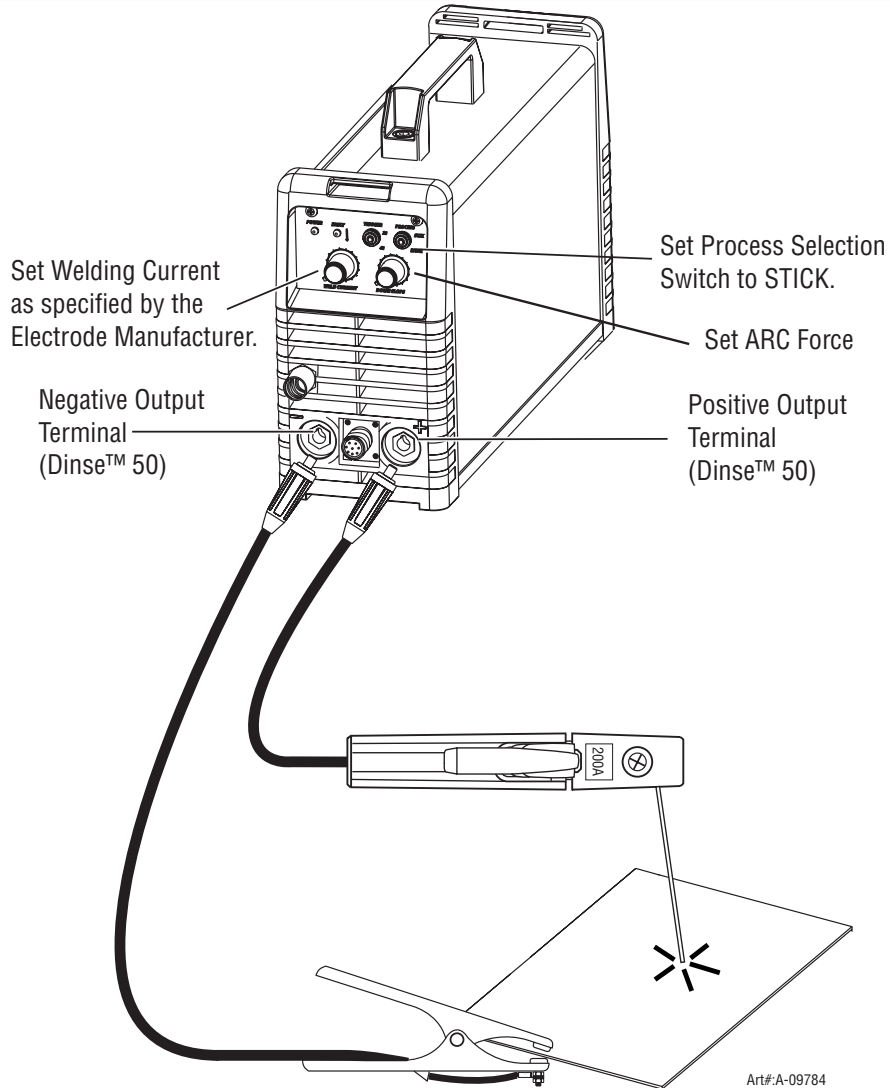

**Figure 3-2 Setup for STICK (MMA) Welding**

**CAUTION**

---

*Before any welding is to begin, be sure to wear all appropriate and recommended safety equipment.*

1. Switch the ON/OFF Switch (located on the rear panel) to OFF.
2. Connect the ground (work) clamp cable to the negative output terminal, and the electrode holder cable to the positive output terminal. It is essential that the male plug is inserted and turned fully clockwise until connector locks in place to achieve reliable electrical connection.

---

**NOTE**

*This set up is known as DC Electrode Positive or reverse polarity. Please consult with the stick electrode manufacturer for specific polarity recommendations.*

3. Connect the ground (work) clamp to your workpiece.
4. Plug the power cable into the appropriate outlet, and turn the switch to the “ON” position. The power L.E.D light should illuminate.
5. Set the “Process Selection Switch” to STICK.
6. Set the weld current control knob to the desired amperage.
7. Set the ARC FORCE control knob to 2.

Minimum (0) provides a soft arc, low spatter & low penetration.

Medium (2) provides a normal arc, improved fusion & normal penetration.

Maximum (10) provides a hard arc & deep penetration.

8. Install a stick electrode in the electrode holder.
9. You are now ready to begin STICK Welding

---

**NOTE**

*Gently strike the electrode on the work piece to generate a welding arc, and slowly move along the work piece while holding a consistent arc length above base metal.*



**3.07 LIFT TIG / HF TIG (GTAW) SETUP**

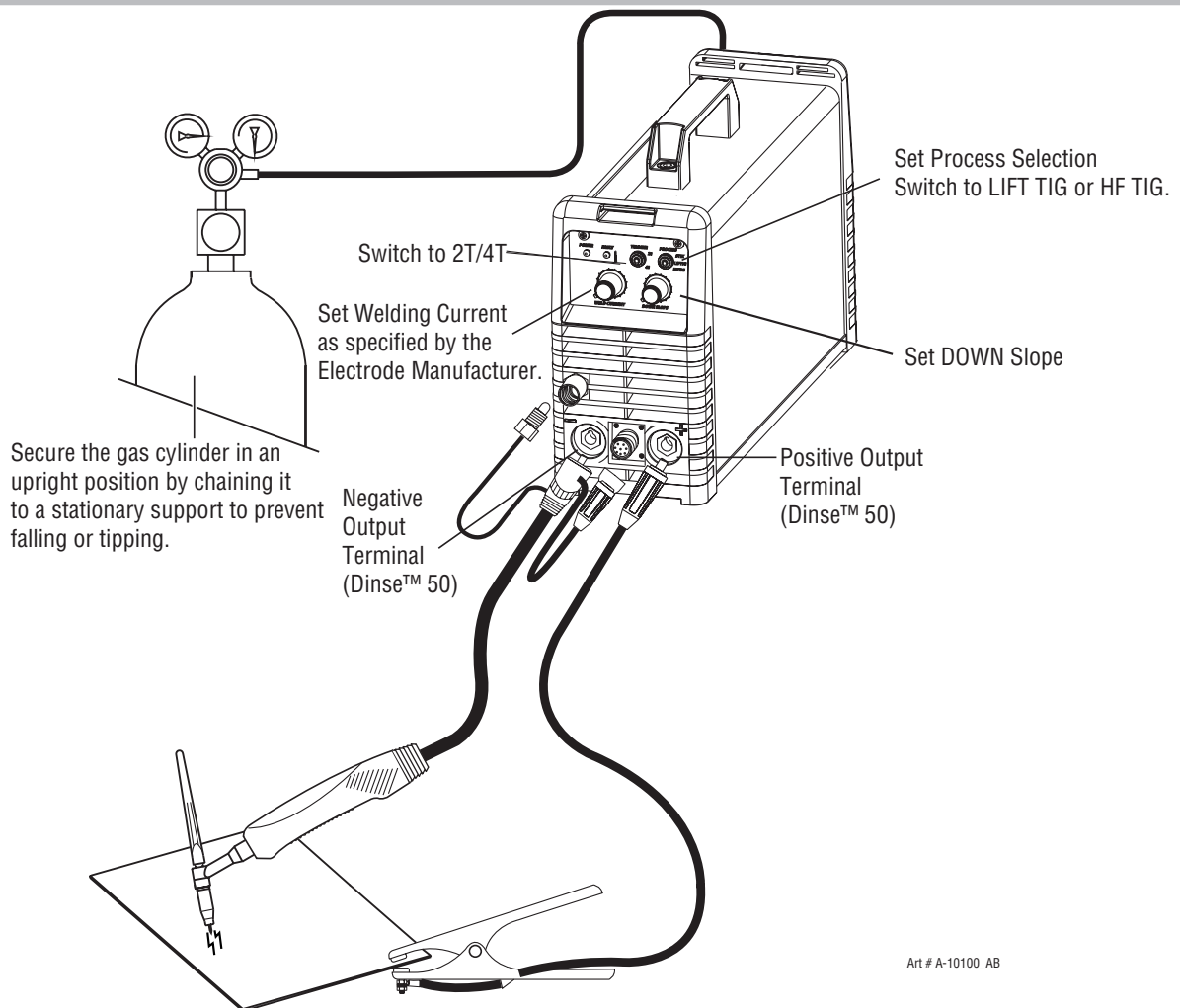

Figure 3-3: Setup for LIFT TIG / HF TIG (GTAW) Welding

**LIFT TIG / HF TIG (GTAW) Sequence of Operation**



**CAUTION**

*Before any welding is to begin, be sure to wear all appropriate and recommended safety equipment.*

1. Switch the ON/OFF Switch (located on the rear panel) to OFF.
2. Connect the ground (work) clamp cable to positive output terminal. It is essential that the male plug is inserted and turned fully clockwise until connector locks in place to achieve reliable electrical connection.
3. Connect the TIG torch as follows:
  - a) Place the power cable into the negative output terminal. It is essential that the male plug is inserted and turned fully clockwise until connector locks in place to achieve reliable electrical connection;
  - b) Place the 8 pin plug into the 8 pin socket. To make connections, align keyway, insert plug, and rotate threaded collar fully clockwise.
  - c) Place the TIG torch gas hose to the gas outlet and tighten with a wrench. Caution: DO NOT over tighten.
4. Using a secured Argon cylinder, slowly crack open then close the cylinder valve while standing off to the side of the valve. This will remove any debris that may be around the valve & regulator seat area.
5. Install the regulator (for details of VICTOR regulator, please refer to 3.08 ) and tighten with a wrench.
6. Connect one end of the supplied gas hose to the outlet of the Argon regulator and tighten with a wrench. Caution: DO NOT over tighten.

7. Connect the other end of the supplied gas hose to the gas inlet fitting on the rear panel of the welder and tighten with a wrench. Caution: DO NOT over tighten.
8. Open the Argon Cylinder Valve to the fully open position.
9. Connect the ground (work) clamp to your work piece.
10. Set the DOWN SLOPE control knob to the desired weld current ramp down time. Refer to Section 4.01.
11. Set the weld current control knob to the desired amperage.
12. The tungsten must be ground to a blunt point in order to achieve optimum welding results. It is critical to grind the tungsten electrode in the direction the grinding wheel is turning.
13. Install the tungsten with approximately 1/8" to 1/4" sticking out from the gas cup, ensuring you have correct sized collet.
14. Tighten the back cap then open the valve on the torch.
15. Plug the power cable into the appropriate outlet, and turn the switch to the "ON" position. The power L.E.D. light should illuminate. Set the "Process Selection Switch" to LIFT TIG and HF TIG
16. You are now ready to begin TIG Welding.

### 3.08 LEAK TESTING THE SYSTEM

Leak test the system before putting into operation.

1. Be sure that there is a valve in the downstream equipment to turn off the gas flow.
2. With the cylinder valve open, adjust the regulator to deliver the maximum required delivery pressure.
3. Close the cylinder valve.
4. Turn the adjusting screw/knob counterclockwise one turn.
  - a) If the high-pressure gauge reading drops, there is a leak in the cylinder valve, inlet fitting, or high-pressure gauge.
  - b) If the low-pressure gauge drops, there is a leak in the downstream equipment, hose, hose fitting, outlet fitting or low-pressure

gauge. Check for leaks using an approved leak detector solution.

- c) If the high-pressure gauge drops and the low-pressure gauge increases at the same time, there is a leak in the regulator seat.
  - d) If the regulator requires service or repair, take it to a qualified repair technician.
5. Once leak testing has been performed and there are no leaks in the system, slowly open the cylinder valve and proceed.



#### WARNING

*If a leak has been detected anywhere in the system, discontinue use and have the system repaired. DO NOT use leaking equipment. Do not attempt to repair a leaking system while the system is under pressure.*

### 3.09 WHEN YOU FINISH USING THE REGULATOR

1. Close the cylinder valve.
2. Open the valve on the downstream equipment. This drains all pressure from the system.
3. Close the valve on the downstream equipment.
4. Turn the adjusting screw counterclockwise to release the tension on the adjusting spring.
5. Check the gauges after a few minutes for verification that the cylinder valve is closed completely.

### 3.10 STORAGE OF THE REGULATOR

When the regulator is not in use and has been removed from the cylinder, it should be stored in an area where it will be protected from dust, oil, and grease. The inlet and outlet should be capped to protect against internal contamination and prevent insects from nesting.

**SECTION 4:  
OPERATION**

Conventional operating procedures apply when using the Welding Power Source, i.e. connect work lead directly to work piece and electrode lead is used to hold the electrode. The welding current range values should be used as a guide only. Current delivered to the arc is dependent on the welding arc voltage, and as welding arc voltage varies between different classes of electrode, welding current at any one setting would vary according to the type of electrode in use. The operator should use the welding current range values as a guide then fine tune the welding current to suit the specific application. Refer to the electrode manufacture's literature for further information.

**4.01 Front Panel**

**Front Panel**

The welding power source is protected by a self re-setting thermostat. The indicator will illuminate if the duty cycle of the power source has been exceeded. If the FAULT light illuminates wait for the FAULT light to extinguish before resuming welding.

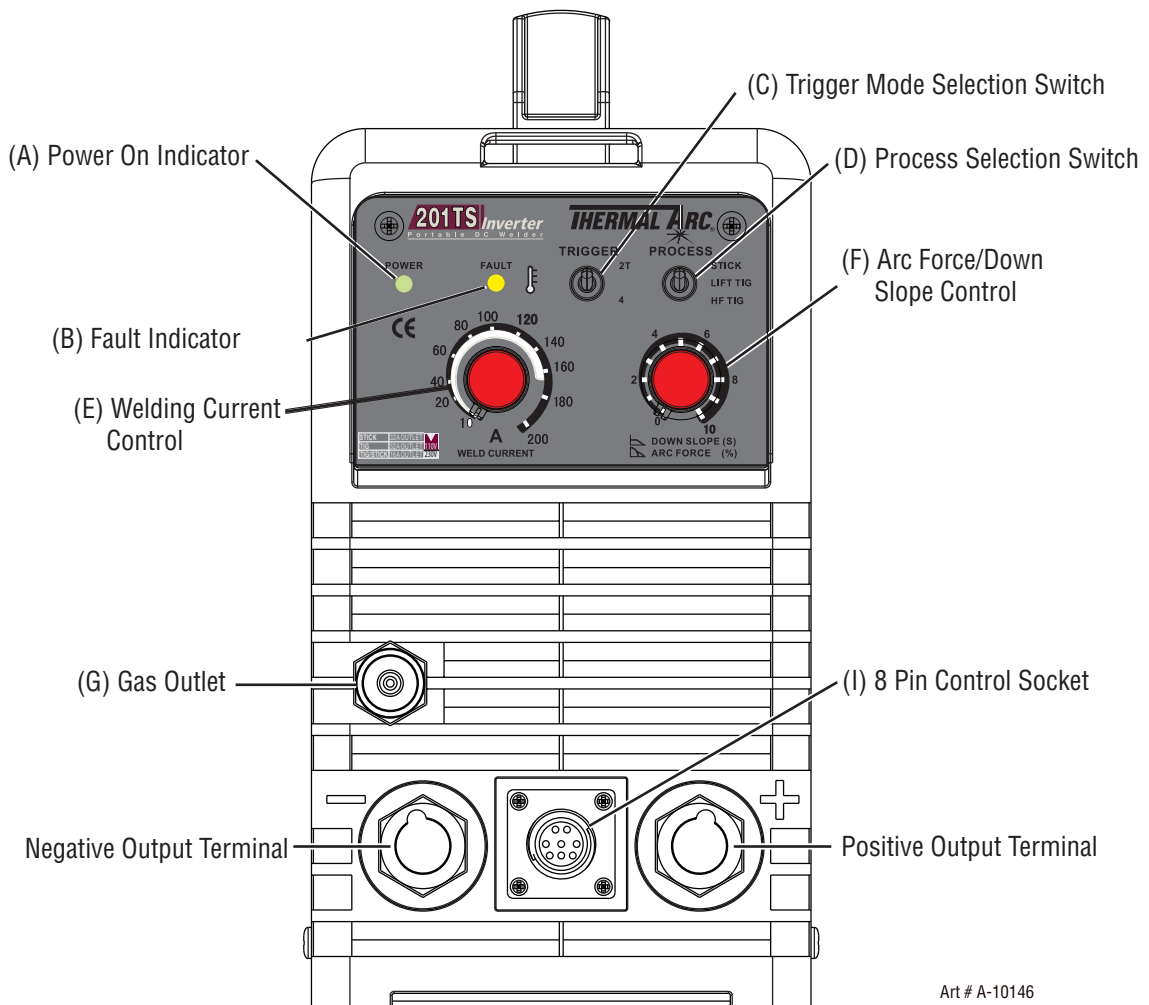

Art # A-10146

Figure 4-1: Thermal Arc 201 TS Controls

**A. POWER Indicator**

The POWER Indicator illuminates when the ON/OFF switch is in the ON position and the correct mains voltage is present.

**B. FAULT Indicator**

If Fault indicator lights up continuously then that is an Overcurrent Condition and needs to be serviced by an Authorized Thermalarc Technician.

**C. TRIGGER Mode Switch (LIFT TIG Mode Only)**

**2T (Normal) Mode**

Press the TIG Torch Trigger Switch or Foot Control and hold depressed to weld. Release the TIG Torch Trigger Switch or Foot Control to stop welding. Down Slope operates in LIFT TIG (GTAW) mode only. While welding if the TIG Torch Trigger Switch is released, the welding current ramps down to zero current over a defined period of time. The time period is determined by the Down Slope Control Knob (F).

**4T (Latch) Mode**

This mode of welding is mainly used for long weld runs. The operator need only to press the TIG Torch Trigger Switch to activate and then release the TIG Torch Trigger Switch to continue to weld, then press the TIG Torch Trigger Switch again and release the TIG Torch Trigger Switch to stop welding. This eliminates the need for the operator to depress the TIG Torch Trigger Switch for the complete length of the weld. The 4T mode incorporates a current slope function which includes a fixed current up slope of 1 second and an adjustable current down slope. Current slope operates in TIG Mode only. Up slope is not adjustable and activates automatically in 4T mode when the TIG torch trigger is depressed. To activate the Down Slope function in 4T mode while welding, the TIG Torch Trigger Switch must be depressed and held while welding which will ramp the Welding Current down to zero over a defined period of time. The time period is determined by the Down Slope Control Knob (F). At any time while welding if the TIG Torch Trigger Switch is depressed and released the arc will extinguish immediately.

**D. Process Selection Switch**

Switches between STICK (MMA), LIFT TIG (GTAW) and HF TIG (GTAW) modes. Refer to Section 3.06 Setup for STICK (MMA) Welding and 3.07 Setup for TIG / HF TIG Welding.

**E. Welding Current Control**

The welding current is increased by turning the Weld Current Control Knob clockwise or decreased by turning the Weld Current Control Knob counterclockwise. The welding current should be set according to the specific application. Refer to application notes in this section for further information.

**F. Arc Force/Down Slope Control**

Arc Force is effective when in STICK (MMA) Mode only. Arc Force control provides an adjustable amount of Arc Force (or “dig”) control. This feature can be particularly beneficial in providing the operator the ability to compensate for variability in joint fit-up in certain situations with particular electrodes. In general increasing the Arc Force control toward ‘10’ (maximum Arc Force) allows

greater penetration control to be achieved. Down Slope operates in TIG mode only. It is used to set the time for weld current to ramp down. Refer to Item C (Trigger Mode Selection Switch) for further information regarding Downslope operation.

**G. Gas Outlet**

The Gas Outlet is a 5/8”-18 UNF female gas fitting and is utilized for the connection of a suitable TIG Torch.

**H. Post Gas Flow (weld current dependant)**

Post Gas Flow is the time Gas flows after the arc has extinguished. The gas flow time is proportional to weld current. This is used to cool and reduce oxidization of the Tungsten Electrode. For example if the Welding Current is set to 10 amps the Post Gas Flow time will be approximately 3 seconds. For a Welding Current set to 160 Amps the Post Gas Flow time will be approximately 10 seconds. The Post Gas Flow time cannot be adjusted independently of the Welding Current.

**I. 8 Pin Remote Socket**

The 8 pin remote socket is used to connect the TIG Torch Trigger Switch to the welding Power Source. To make connections, align keyway, insert plug, and rotate threaded collar fully clockwise.

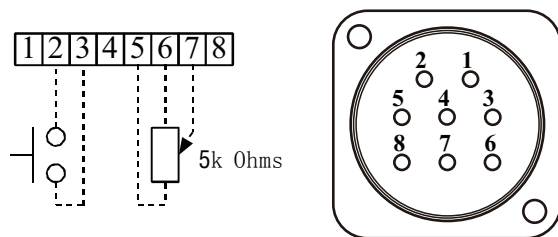

Front View of 8 Pin Socket

Art # A-09815\_AB

Plug Pin	Function
1	
2	Torch Switch Input (24V) to energize weld current. (connect pin 2&3 to turn on welding current)
3	Torch Switch Input (0V) to energize weld current. (connect pin 2&3 to turn on welding current)
4	
5	5k ohm (maximum) connection to 5k ohm remote control potentiometer
6	Zero ohm (minimum) connection to 5k ohm remote control potentiometer
7	Wiper arm connection to 5k ohm remote control potentiometer
8	

**NOTE**

Remote Welding Current Control is not available on this model.

J. ON/OFF Switch (located on rear panel not shown)

This switch controls the Mains Supply Voltage to the Power Source.

**4.02 Welding Current Control Explanation**

**32 Amp Outlet**

The mains power 32 Amp circuit breaker or fuse should not trip at this Weld Current value when STICK welding.

The environmental conditions that may cause the mains power 32 Amp circuit breaker or fuse to trip are:

- a) High ambient temperature
- b) Worn parts in circuit breaker
- c) Using an extension cable
- d) Low line mains power voltage

**Output Scale for 110V**



The inside number scale identifies the available output weld current for STICK or LIFT TIG weld modes.

STICK Mode:  Identifies the STICK weld point for 32 Amp outlet.

Exceeding these points will cause nuisance tripping of the circuit breaker or fuse.

Nuisance tripping should not occur on a 16 Amp outlet.

**Output Scale for 230V**

The outside number scale identifies the available output weld current for STICK or LIFT TIG/HF TIG weld modes.

Nuisance tripping should not occur on a 32A 230V outlet for both STICK & LIFT TIG/HF TIG Modes.

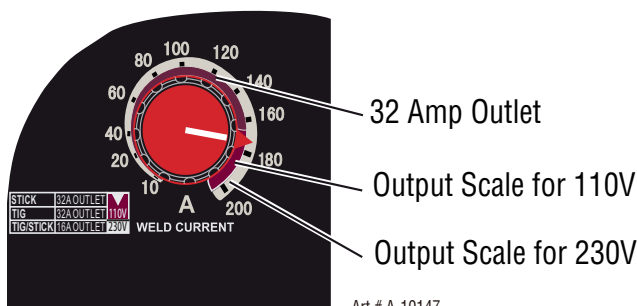

Figure 4-2: Current Control

**4.03 STICK (MMA) Electrode Polarity**

Stick electrodes are generally connected to the "+" Positive Output Terminal and the work lead to the "-" Negative Output Terminal but if in doubt consult the electrode manufacturers literature for further information.

**4.04 Effects of Stick Welding Various Materials**

**High Tensile and Alloy Steels**

The two most prominent effects of welding these steels are the formation of a hardened zone in the weld area, and, if suitable precautions are not taken, the occurrence in this zone of under-bead cracks. Hardened zone and under-bead cracks in the weld area may be reduced by using the correct electrodes, preheating, using higher current settings, using larger electrodes sizes, short runs for larger electrode deposits or tempering in a furnace.

**Manganese Steels**

The effect on manganese steel of slow cooling from high temperatures is to embrittle it. For this reason it is absolutely essential to keep manganese steel cool during welding by quenching after each weld or skip welding to distribute the heat.

**Cast Iron**

Most types of cast iron, except white iron, are weldable. White iron, because of its extreme brittleness, generally cracks when attempts are made to weld it. Trouble may also be experienced when welding white-heart malleable, due to the porosity caused by gas held in this type of iron.

**Copper and Alloys**

The most important factor is the high rate of heat conductivity of copper, making pre-heating of heavy sections necessary to give proper fusion of weld and base metal.

**Types of Electrodes**

Arc Welding electrodes are classified into a number of groups depending on their applications. There are a great number of electrodes used for specialized industrial purposes which are not of particular interest for everyday general work. These include some low hydrogen types for high tensile steel, cellulose types for welding large diameter pipes, etc The range of electrodes dealt with in this publication will cover the vast majority of applications likely to be encountered; are all easy to use.

Metal Being Joined	Electrode	Comments
Mild Steel	E6011	This electrode is used for all-position welding or for welding on rusty, dirty, less-than-new metal. It has a deep, penetrating arc and is often the first choice for repair or maintenance work.
Mild Steel	E6013	This all-position, electrode is used for welding clean, new sheet metal. Its soft arc has minimal spatter, moderate penetration and an easy-to-clean slag.
Mild Steel	E7014	All positional, ease to use electrode for use on thicker steel than E6013. Especially suitable sheet metal lap joints and fillet welds, general purpose plate welding.
Mild Steel	E7018	A low-hydrogen, all-position electrode used when quality is an issue or for hard-to-weld metals. It has the capability of producing more uniform weld metal, which has better impact properties at low temperatures.
Cast Iron	Eni-Cl	Suitable for joining all cast irons except white cast iron.
Stainless Steel	E318L-16	High corrosion resistances. Ideal for dairy work etc.

**4.05 GTAW Electrode Polarity**

Connect the TIG torch to the "-" Negative Output Terminal and the work lead to the "+" Positive Output Terminal for direct current straight polarity. Direct current straight polarity is the most widely used polarity for DC TIG welding. It allows limited wear of the electrode since 70% of the heat is concentrated at the work piece.

**4.06 Guide for Selecting Filler Wire**

Filler Wire Diameter	DC Current (Amps)
1.6mm (1/16")	20 - 90
2.4mm (3/32")	65 - 115
3.2mm (1/8")	100 - 165

**4.07 Tungsten Electrode Current Ranges**

Electrode Diameter	DC Current
1.0mm (.040")	25 - 85
1.6mm (1/16")	50 - 160
2.4mm (3/32")	135 - 235

**4.08 Shielding Gas Selection**

Alloy	Shielding Gas
Carbon Steel	Welding Argon
Stainless Steel	Welding Argon
Nickel Alloy	Welding Argon
Copper	Welding Argon
Titanium	Welding Argon

**4.08 Shielding Gas Selection**

Alloy	Shielding Gas
Carbon Steel	Welding Argon
Stainless Steel	Welding Argon
Nickel Alloy	Welding Argon
Copper	Welding Argon
Titanium	Welding Argon

**4.09 Tungsten Electrode Types**

Electrode Type (Ground Finish)	Welding Application	Features	Color Code
Thoriated 2%	DC welding of mild steel, stainless steel and copper.	Excellent arc starting, long life, high current carrying capacity.	Red
Ceriated 2%	AC & DC welding of mild steel, stainless steel, copper, aluminium, magnesium and their alloys.	Longer life, more stable arc, easier starting, wider current range, narrower & more concentrated arc.	Grey

**4.10 TIG Welding Parameters for Steel**

Base Metal Thickness	DC Current		Electrode Diameter	Filler Rod Diameter	Argon Gas Flow Rate	Joint / Type
	Mild Steel	Stainless Steel				
1.0mm (0.040")	35-45	20-30	1.0mm (0.040")	1.6mm (1/16" )	10 CFH (5 LPM)	Butt/Corner
	40-50	25-35				Lap/Filler
1.2mm (0.045")	45-55	30-45	1.0mm (0.040")	1.6mm (1/16")	13 CFH (6 LPM)	Butt/Corner
	50-60	35-50				Lap/Filler
1.6mm (1/16")	60-70	40-60	1.6mm (1/16")	1.6mm (1/16")	15 CFH (7 LPM)	Butt/Corner
	70-90	50-70				Lap/Filler
3.2mm (1/8")	80-100	65-85	1.6mm (1/16")	2.4mm (3/32")	15CFH (7 LPM)	Butt/Corner
	90-115	90-110				Lap/Filler
4.8mm (3/16")	115-135	100-125	2.4mm (3/32")	3.2mm (1/8")	21CFH (10 LPM)	Butt/Corner
	140-165	125-150				Lap/Filler
6.4mm (1/4")	160-175	135-160	3.2mm (1/8")	4.0mm (5/32")	21CFH (10 LPM)	Butt/Corner
	170-200	160-180				Lap/Filler

**4.11 Arc Welding Practice**

The techniques used for arc welding are almost identical regardless of what types of metals are being joined. Naturally enough, different types of electrodes would be used for different metals as described in the preceding section.

**4.12 Welding Position**

The electrodes dealt with in this publication can be used in most positions, i.e. they are suitable for welding in flat, horizontal, vertical and overhead positions. Numerous applications call for welds to be made in positions intermediate between these. Some of the common types of welds are shown in Figures 4-3 through 4-10.

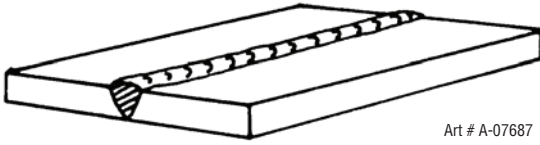

Art # A-07687

Figure 4-3: Flat position, down hand butt weld

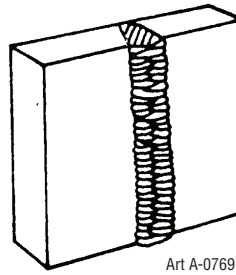

Art A-07691

Figure 4-7: Vertical position, butt weld

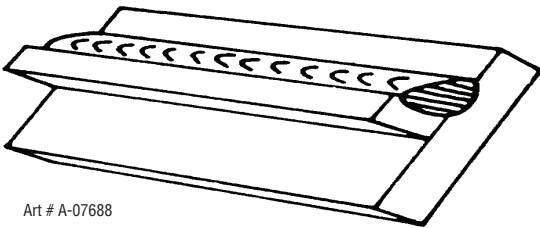

Art # A-07688

Figure 4-4: Flat position, gravity fillet weld

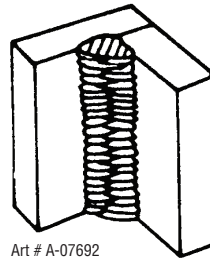

Art # A-07692

Figure 4-8: Vertical position, fillet weld

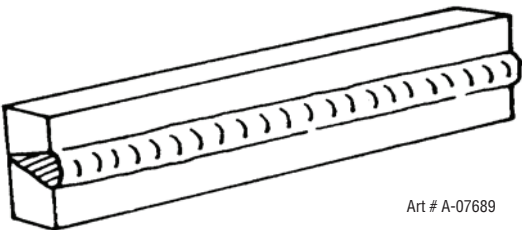

Art # A-07689

Figure 4-5: Horizontal position, butt weld

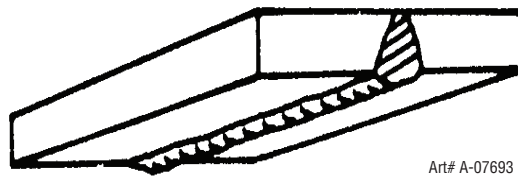

Art# A-07693

Figure 4-9: Overhead position, butt weld

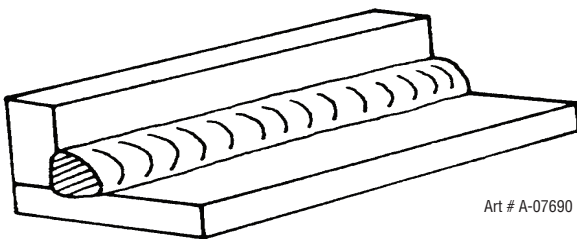

Art # A-07690

Figure 4-6: Horizontal - Vertical (HV) position

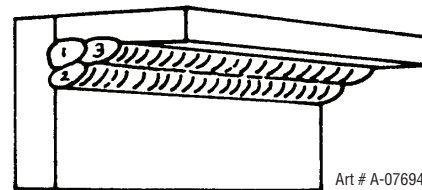

Art # A-07694

Figure 4-10: Overhead position, fillet weld



**4.13 Joint Preparations**

In many cases, it will be possible to weld steel sections without any special preparation. For heavier sections and for repair work on castings, etc., it will be necessary to cut or grind an angle between the pieces being joined to ensure proper penetration of the weld metal and to produce sound joints.

In general, surfaces being welded should be clean and free of rust, scale, dirt, grease, etc. Slag should be removed from oxy-cut surfaces. Typical joint designs are shown in Figure 4-11.

**Open Square Butt Joint**

Gap varies from 1.6mm (1/16") to 4.8mm (3/16") depending on plate thickness

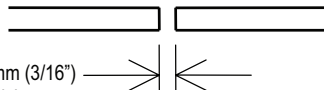

**Single Vee Butt Joint**

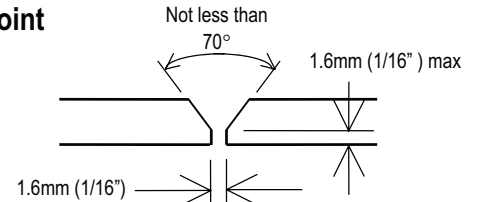

**Single Vee Butt Joint**

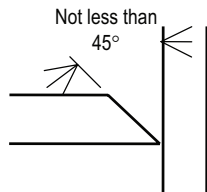

**Double Vee Butt Joint**

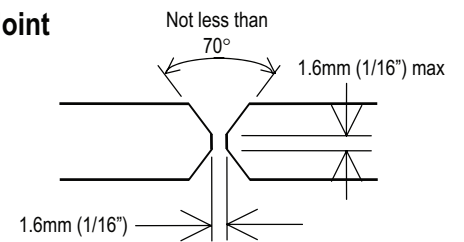

**Lap Joint**

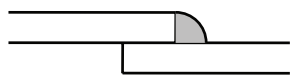

**Fillet Joint**

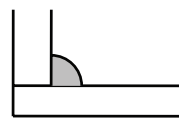

**Tee Joints**  
(Fillet both sides of the joint)

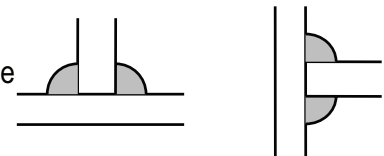

**Corner Weld**

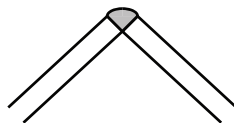

**Edge Joint**

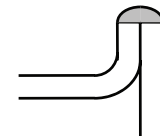

**Plug Weld**

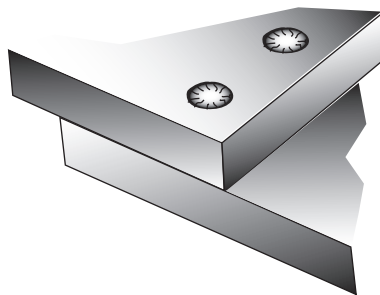

**Plug Weld**

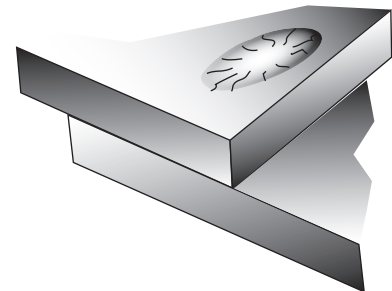

Art # A-07695\_AE

Figure 4-11: Typical joint designs for arc welding

## 4.14 Arc Welding Technique

### A Word to Beginners

For those who have not yet done any welding, the simplest way to commence is to run beads on a piece of scrap plate. Use mild steel plate about 6.4mm (1/4") thick and a 3.2mm (1/8") electrode. Clean any paint, loose scale or grease off the plate and set it firmly on the work bench so that welding can be carried out in the downhand position. Make sure that the work clamp is making good electrical contact with the work, either directly or through the work table. For light gauge material, always clamp the work lead directly to the job, otherwise a poor circuit will probably result.

## 4.15 The Welder

Place yourself in a comfortable position before beginning to weld. Get a seat of suitable height and do as much work as possible sitting down. Don't hold your body tense. A taut attitude of mind and a tensed body will soon make you feel tired. Relax and you will find that the job becomes much easier. You can add much to your peace of mind by wearing a leather apron and gauntlets. You won't be worrying then about being burnt or sparks setting alight to your clothes.

Place the work so that the direction of welding is across, rather than to or from, your body. The electrode holder lead should be clear of any obstruction so that you can move your arm freely along as the electrode burns down. If the lead is slung over your shoulder, it allows greater freedom of movement and takes a lot of weight off your hand. Be sure the insulation on your cable and electrode holder is not faulty, otherwise you are risking an electric shock.

## 4.16 Striking the Arc

Practice this on a piece of scrap plate before going on to more exacting work. You may at first experience difficulty due to the tip of the electrode "sticking" to the work piece. This is caused by making too heavy a contact with the work and failing to withdraw the electrode quickly enough. A low amperage will accentuate it. This freezing-on of the tip may be overcome by scratching the electrode along the plate surface in the same way as a match is struck. As soon as the arc is established, maintain a 1.6mm (1/16") to 3.2mm (1/8") gap between the burning electrode end and the parent metal. Draw the electrode slowly along as it melts down.

Another difficulty you may meet is the tendency, after the arc is struck, to withdraw the electrode so far that the arc is broken again. A little practice will soon remedy both of these faults.

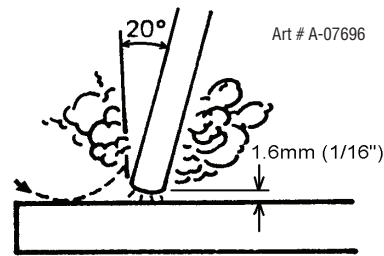

Figure 4-12: Striking an arc

## 4.17 Arc Length

The securing of an arc length necessary to produce a neat weld soon becomes almost automatic. You will find that arc produces a crackling or spluttering noise and the weld metal comes across in large, irregular blobs. The weld bead is flattened and spatter increases. A short arc is essential if a high quality weld is to be obtained although if it is too short there is the danger of it being blanketed by slag and the electrode tip being solidified in. If this should happen, give the electrode a quick twist back over the weld to detach it. Contact or "touch-weld" electrodes such as E7014 electrode do not stick in this way, and make welding much easier.

## 4.18 Rate of Travel

After the arc is struck, your next concern is to maintain it, and this requires moving the electrode tip towards the molten pool at the same rate as it is melting away. At the same time, the electrode has to move along the plate to form a bead. The electrode is directed at the weld pool at about 20° from the vertical. The rate of travel has to be adjusted so that a well-formed bead is produced.

If the travel is too fast, the bead will be narrow and strung out and may even be broken up into individual globules. If the travel is too slow, the weld metal piles up and the bead will be too large.

**4.19 Making Welded Joints**

Having attained some skill in the handling of an electrode, you will be ready to go on to make up welded joints.

**A. Butt Welds**

Set up two plates with their edges parallel, as shown in Figure 4-12, allowing 1.6mm (1/16") to 2.4mm (3/32") gap between them and tack weld at both ends. This is to prevent contraction stresses from the cooling weld metal pulling the plates out of alignment. Plates thicker than 6.4mm (1/4") should have their mating edges beveled to form a 70° to 90° included angle. This allows full penetration of the weld metal to the root. Using a 3.2mm (1/8") E7014 electrode at 120 amps, deposit a run of weld metal on the bottom of the joint.

Do not weave the electrode, but maintain a steady rate of travel along the joint sufficient to produce a well-formed bead. At first you may notice a tendency for undercut to form, but keeping the arc length short, the angle of the electrode at about 20° from vertical, and the rate of travel not too fast, will help eliminate this. The electrode needs to be moved along fast enough to prevent the slag pool from getting ahead of the arc. To complete the joint in thin plate, turn the job over, clean the slag out of the back and deposit a similar weld.

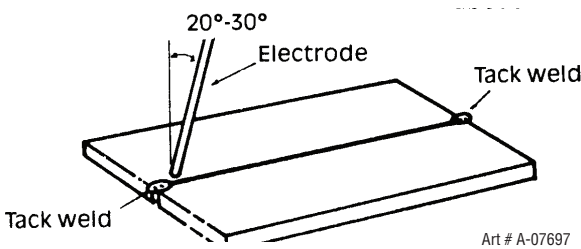

Figure 4-13: Butt weld

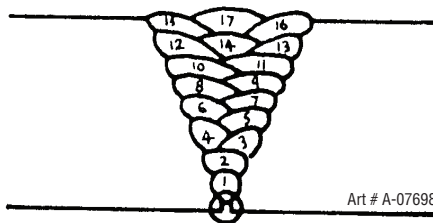

Figure 4-14: Weld build up sequence

Heavy plate will require several runs to complete the joint. After completing the first run, chip the slag out and clean the weld with a wire brush. It is important to do this to prevent slag being trapped by the second run. Subsequent runs are then deposited using either a weave technique or single beads laid down in the sequence shown in Figure 4-13. The width of weave should not be more than three times the core wire diameter of the electrode. When the joint is completely filled, the back is either machined, ground or gouged out to remove slag which may be trapped in the root, and to prepare a suitable joint for depositing the backing run. If a backing bar is used, it is not usually necessary to remove this, since it serves a similar purpose to the backing run in securing proper fusion at the root of the weld.

**B. Fillet Welds**

These are welds of approximately triangular cross-section made by depositing metal in the corner of two faces meeting at right angles. Refer to Figure 4-5.

A piece of angle iron is a suitable specimen with which to begin, or two lengths of strip steel may be tacked together at right angles. Using a 3.2mm (1/8") E7014 electrode at 120 amps, position angle iron with one leg horizontal and the other vertical. This is known as a horizontal-vertical (HV) fillet. Strike the arc and immediately bring the electrode to a position perpendicular to the line of the fillet and about 45° from the vertical. Some electrodes require to be sloped about 20° away from the perpendicular position to prevent slag from running ahead of the weld. Refer to Figure 4-14. Do not attempt to build up much larger than 6.4mm (1/4") width with a 3.2mm (1/8") electrode, otherwise the weld metal tends to sag towards the base, and undercut forms on the vertical leg. Multi-runs can be made as shown in Figure 4-15. Weaving in HV fillet welds is undesirable.

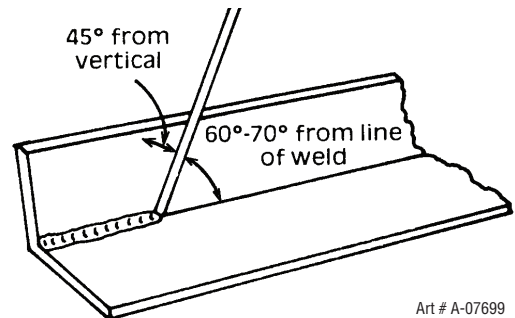
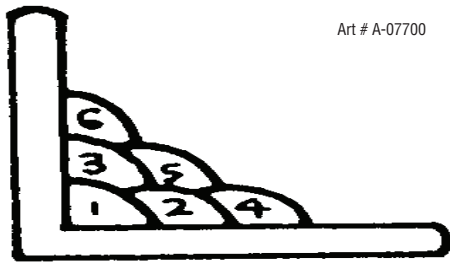

Figure 4-15: Electrode position for HV fillet weld



Art # A-07700

Figure 4-16: Multi-runs in HV fillet weld

**C. Vertical Welds**

**1. Vertical Up**

Tack weld a three feet length of angle iron to your work bench in an upright position. Use a 3.2mm (1/8") E7014 electrode and set the current at 120 amps. Make yourself comfortable on a seat in front of the job and strike the arc in the corner of the fillet. The electrode needs to be about 10° from the horizontal to enable a good bead to be deposited. Refer Figure 4-16. Use a short arc, and do not attempt to weave on the first run. When the first run has been completed de-slag the weld deposit and begin the second run at the bottom. This time a slight weaving motion is necessary to cover the first run and obtain good fusion at the edges. At the completion of each side motion, pause for a moment to allow weld metal to build up at the edges, otherwise undercut will form and too much metal will accumulate in the centre of the weld. Figure 4-17 illustrates multi-run technique and Figure 4-18 shows the effects of pausing at the edge of weave and of weaving too rapidly.

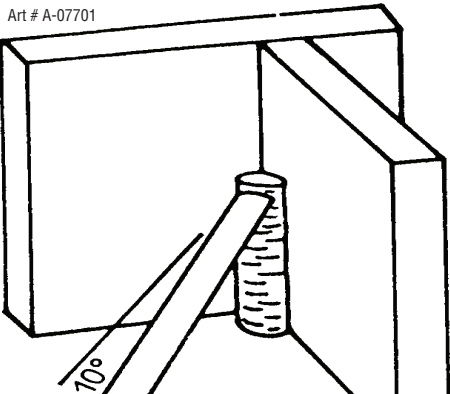

Figure 4-17: Single run vertical fillet weld

Art # A-07702

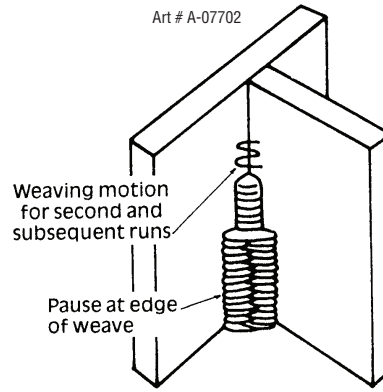
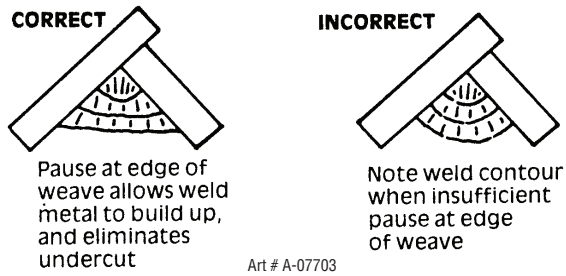

Figure 4-18: Multi run vertical fillet weld



Art # A-07703

Figure 4-19: Examples of vertical fillet welds

**2. Vertical Down**

The E7014 electrode makes welding in this position particularly easy. Use a 3.2mm (1/8") electrode at 120 amps. The tip of the electrode is held in light contact with the work and the speed of downward travel is regulated so that the tip of the electrode just keeps ahead of the slag. The electrode should point upwards at an angle of about 45°.

**3. Overhead Welds**

Apart from the rather awkward position necessary, overhead welding is not much more difficult than downhand welding. Set up a specimen for overhead welding by first tacking a length of angle iron at right angles to another piece of angle iron or a length of waste pipe. Then tack this to the work bench or hold in a vice so that the specimen is positioned in the overhead position as shown in the sketch. The electrode is held at 45° to the horizontal and tilted 10° in the line of travel (Figure 4-19). The tip of the electrode may be touched lightly on the metal, which helps to give a steady run. A weave technique is not advisable for overhead fillet welds. Use a 3.2mm (1/8") E6012 electrode at 120 amps, and deposit the first run by simply drawing the electrode along at a steady rate. You will notice that the weld deposit is rather convex, due to the effect of gravity before the metal freezes.

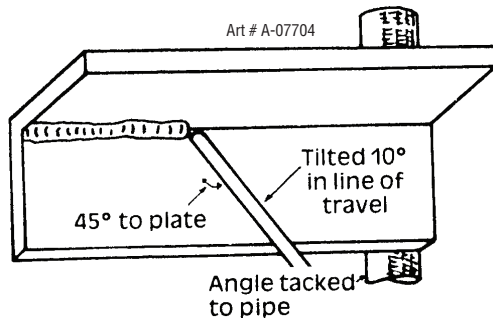

Figure 4-20: Overhead fillet weld

**4.20 Distortion**

Distortion in some degree is present in all forms of welding. In many cases it is so small that it is barely perceptible, but in other cases allowance has to be made before welding commences for the distortion that will subsequently occur. The study of distortion is so complex that only a brief outline can be attempted here.

**4.21 The Cause of Distortion**

Distortion is caused by:

**A. Contraction of Weld Metal:**

Molten steel shrinks approximately 11 per cent in volume on cooling to room temperature. This means that a cube of molten metal would contract approximately 2.2 per cent in each of its three dimensions. In a welded joint, the metal becomes attached to the side of the joint and cannot contract freely. Therefore, cooling causes the weld metal to flow plastically, that is, the weld itself has to stretch if it is to overcome the effect of shrinking volume and still be attached to the edge of the joint. If the restraint is very great, as, for example, in a heavy section of plate, the weld metal may crack. Even in cases where the weld metal does not crack, there will still remain stresses “locked-up” in the structure. If the joint material is relatively weak, for example, a butt joint in 2.0mm (5/64”) sheet, the contracting weld metal may cause the sheet to become distorted.

**B. Expansion and Contraction of Parent Metal in the Fusion Zone:**

While welding is proceeding, a relatively small volume of the adjacent plate material is heated to a very high temperature and attempts to expand in all directions. It is able to do this freely at right angles to the surface of the plate (i.e., “through the weld”), but when it attempts to expand “across the weld” or “along the weld”, it meets considerable resistance, and to fulfill the desire for continued expansion, it has to deform plastically, that is, the metal adjacent to the weld is at a high temperature and hence rather soft, and, by expanding, pushes against the cooler, harder metal further away, and tends to bulge (or is “upset”). When the weld area begins to cool, the “upset” metal attempts to contract as much as it expanded, but, because it has been “upset”, it does not resume its former shape, and the contraction of the new shape exerts a strong pull on adjacent metal. Several things can then happen.

The metal in the weld area is stretched (plastic deformation), the job may be pulled out of shape by the powerful contraction stresses (distortion), or the weld may crack, in any case, there will remain “locked-up” stresses in the job. Figures 4-20 and 4- 21 illustrate how distortion is created.

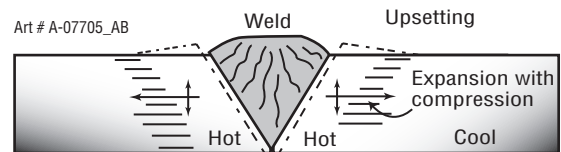

Figure 4-21: Parent metal expansion

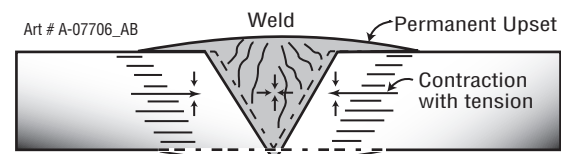

Figure 4-22: Parent metal contraction

**4.22 Overcoming Distortion Effects**

There are several methods of minimizing distortion effects.

**A. Peening**

This is done by hammering the weld while it is still hot. The weld metal is flattened slightly and because of this the tensile stresses are reduced a little. The effect of peening is relatively shallow, and is not advisable on the last layer.

**B. Distribution of Stresses**

Distortion may be reduced by selecting a welding sequence which will distribute the stresses suitably so that they tend to cancel each other out. See Figures 4-25 through 4-28 for various weld sequences. Choice of a suitable weld sequence is probably the most effective method of overcoming distortion, although an unsuitable sequence may exaggerate it. Simultaneous welding of both sides of a joint by two welders is often successful in eliminating distortion.

**C. Restraint of Parts**

Forcible restraint of the components being welded is often used to prevent distortion. Jigs, positions, and tack welds are methods employed with this in view.

**D. Presetting**

It is possible in some cases to tell from past experience or to find by trial and error (or less frequently, to calculate) how much distortion will take place in a given welded structure. By correct pre-setting of the components to be welded, constructional stresses can be made to pull the parts into correct alignment. A simple example is shown in Figure 4-22.

**E. Preheating**

Suitable preheating of parts of the structure other than the area to be welded can be sometimes used to reduce distortion. Figure 4-23 shows a simple application. By removing the heating source from b and c as soon as welding is completed, the sections b and c will contract at a similar rate, thus reducing distortion.

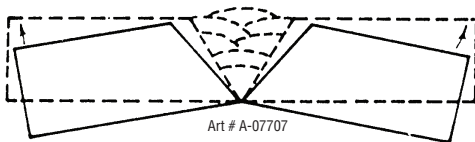
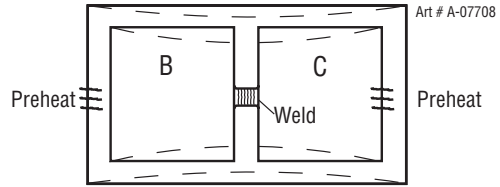

Figure 4-23: Principle of presetting



Dotted lines show effect if no preheat is used

Figure 4-24: Reduction of distortion by preheating

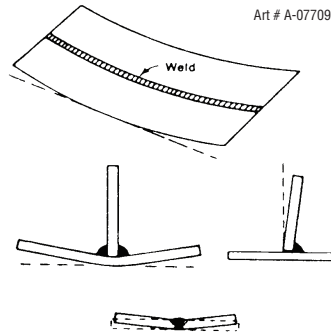

Figure 4-25: Examples of distortion

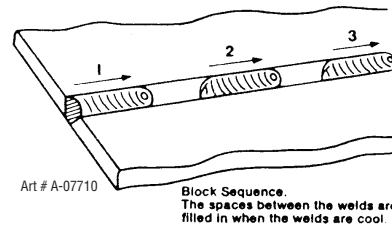

Figure 4-26: Welding sequence

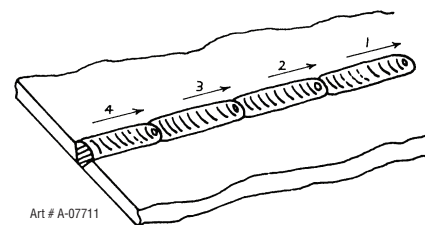

Figure 4-27: Step back sequence

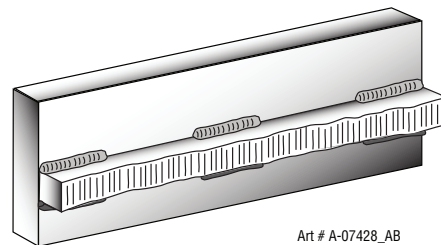

Figure 4-28: Chain intermittent welding

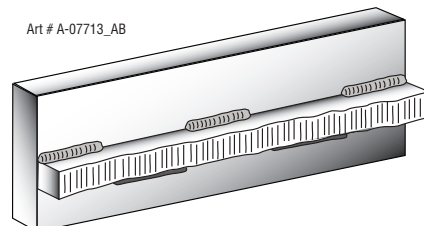

Figure 4-29: Staggered intermittent welding

**SECTION 5:  
SERVICE**

**5.01 Maintenance and Inspection**

The only routine maintenance required for the power supply is a thorough cleaning and inspection, with the frequency depending on the usage and the operating environment.

To clean the unit, open the enclosure and use a vacuum cleaner to remove any accumulated dirt and dust. The unit should also be wiped clean, if necessary; with solvents that are recommended for cleaning electrical apparatus.



**WARNING**

*There are extremely dangerous voltages and power levels present inside this product. Disconnect primary power at the source before opening the enclosure. Wait at least two minutes before opening the enclosure to allow the primary capacitors to discharge.*



**CAUTION**

*Do not blow air into the power supply during cleaning. Blowing air into the unit can cause metal particles to interfere with sensitive electrical components and cause damage to the unit.*



**Warning!**  
Disconnect input power before maintaining.

Maintain more often if used under severe conditions

**Each Use**

Visual check of regulator and pressure



Visual check of torch Consumable parts



**Weekly**

Visually inspect the torch body and consumables

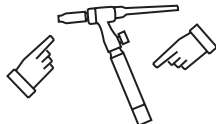

Visually inspect the cables and leads. Replace as needed

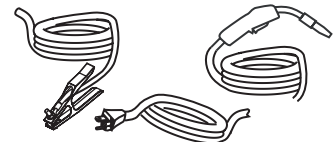

**3 Months**

Replace all broken parts

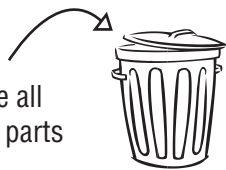

Clean exterior of power supply

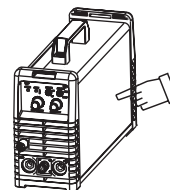

**6 Months**

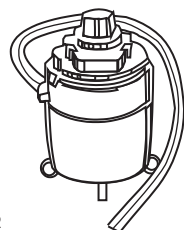

Art # A-10002

Bring the unit to an authorized Thermal Arc Service Centre to remove any accumulated dirt and dust from the interior. This may need to be done more frequently under exceptionally dirty conditions.

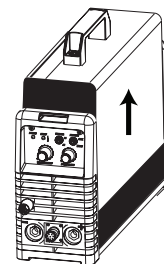

**5.02 STICK (MMA) Welding Problems**

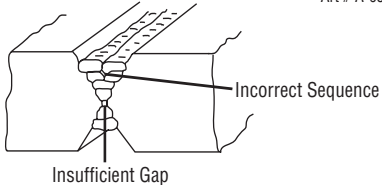
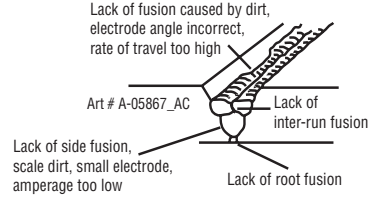
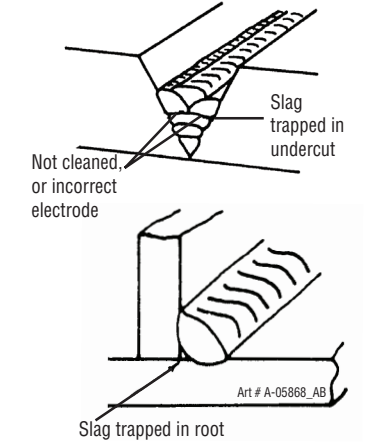
Description	Possible Cause	Remedy
<p>1. Gas pockets or voids in weld metal (Porosity).</p>	<p>A. Electrodes are damp. B. Welding current is too high. C. Surface impurities such as oil, grease, paint, etc.</p>	<p>A. Dry electrodes before use. B. Reduce welding current. C. Clean joint before welding</p>
<p>2. Crack occurring in weld metal soon after solidification commences.</p>	<p>A. Rigidity of joint. B. Insufficient throat thickness. C. Cooling rate is too high.</p>	<p>A. Redesign to relieve weld joint of severe stresses or use crack resistance electrodes. B. Travel slightly slower to allow greater build up in throat. C. Preheat plate and cool slowly.</p>
<p>3. A gap is left by failure of the weld metal to fill the root of the weld.</p> <p style="text-align: right; font-size: small;">Art # A-05866_AC</p> 	<p>A. Welding current is too low. B. Electrode too large for joint. C. Insufficient gap. D. Incorrect sequence.</p>	<p>A. Increase welding current B. Use smaller diameter electrode. C. Allow wider gap. D. Use correct build-up sequence.</p>
<p>4. Portions of the weld run do not fuse to the surface of the metal or edge of the joint</p> 	<p>A. Small electrodes used on heavy cold plate. B. Welding current is too low. C. Wrong electrode angle. D. Travel speed of electrode is too high. E. Scale or dirt on joint surface.</p>	<p>A. Use larger electrodes and preheat the plate. B. Increase welding current C. Adjust angle so the welding arc is directed more into the base metal D. Reduce travel speed of electrode E. Clean surface before welding.</p>
<p>5. Non-metallic particles are trapped in the weld metal (slag inclusion).</p> 	<p>A. Non-metallic particles may be trapped in undercut from previous run. B. Joint preparation too restricted. C. Irregular deposits allow slag to be trapped. D. Lack of penetration with slag trapped beneath weld bead. E. Rust or mill scale is preventing full fusion. F. Wrong electrode for position in which welding is done.</p>	<p>A. If bad undercut is present, clean slag out and cover with a run from a smaller diameter electrode. B. Allow for adequate penetration and room for cleaning out the slag. C. If very bad, chip or grind out irregularities. D. Use smaller electrode with sufficient current to give adequate penetration. Use suitable tools to remove all slag from corners. E. Clean joint before welding. F. Use electrodes designed for position in which welding is done, otherwise proper control of slag is difficult.</p>



**5.03 TIG Welding Problems**

Weld quality is dependent on the selection of the correct consumables, maintenance of equipment and proper welding technique.

Description	Possible Cause	Remedy
1. Excessive bead build-up or poor penetration or poor fusion at edges of weld.	Welding current is too low	Increase weld current and/or change joint preparation.
2. Weld bead too wide and flat or undercut at edges of weld or excessive burn through.	Welding current is too high.	Decrease welding current.
3. Weld bead too small or insufficient penetration or ripples in bead are widely spaced apart.	Travel speed too fast.	Reduce travel speed.
4. Weld bead too wide or excessive bead build up or excessive penetration in butt joint.	Travel speed is too slow.	Increase travel speed.
5. Uneven leg length in fillet joint.	Wrong placement of filler rod.	Re-position filler rod.
6. Electrode melts when arc is struck.	Electrode is connected to the "+" Positive Output Terminal.	Connect the electrode to the "-" Negative Output Terminal.
7. Dirty weld pool.	A. Electrode contaminated through contact with work piece or filler rod material. B. Gas contaminated with air.	A. Clean the electrode by grinding contaminates off. B. Check gas lines for cuts and loose fitting or change gas cylinder.
8. Poor weld finish.	Inadequate shielding gas.	Increase gas flow or check gas line for problems
9. Arc flutters during TIG welding.	Tungsten electrode is too large for the welding current.	Select the right size electrode. Refer to section Tungsten Electrode Current Ranges.
10. Welding arc cannot be established.	A. Work clamp is not connected to the work piece or the work/torch leads are not connected to the correct welding terminals. B. Torch lead is disconnected. C. Gas flow incorrectly set, cylinder empty or the torch valve is off.	A. Connect the work clamp to the work piece or connect the work/torch leads to the correct welding terminals. B. Connect it to the "-" Negative Output Terminal. C. Select the right flow rate, change cylinder or turn torch valve on.
11. Electrode melts or oxidizes when an arc is struck.	A. No gas is flowing to welding region. B. Torch is clogged with dust. C. Gas hose is cut. D. Gas passage contains impurities.  E. Gas regulator turned off. F. Torch valve is turned off. G. The electrode is too small for the welding current.	A. Check the gas lines for kinks or breaks or cylinder contains gas. B. Clean torch. C. Replace gas hose. D. Disconnect gas hose from torch then raise gas pressure and blow out impurities. E. Turn on. F. Turn on. G. Increase electrode diameter or reduce the welding current.

**TIG Welding Problems (Continued)**

Description	Possible Cause	Remedy
12. Arc start is not smooth.	A. Tungsten electrode is too large for the welding current. B. The wrong electrode is being used for the welding job. C. Gas flow rate is too high. D. Incorrect shield gas is being used. E. Poor work clamp connection to work piece.	A. Refer to section Tungsten Electrode Current Ranges for the correct size. B. Refer to section Tungsten Electrode Types for the correct electrode type. C. Select the correct flow rate for the welding job. D. Use 100% argon for TIG welding. E. Improve connection to work piece.



**WARNING**

*There are extremely dangerous voltages and power levels present inside this product. Do not attempt to repair unless you are an Accredited Thermal Arc Service Agent and you have had training in power measurements and troubleshooting techniques. If major complex subassemblies are faulty, then the Welding Power Source must be returned to an Accredited Thermal Arc Service Agent for repair.*

**5.04 Power Source Problems**

Description	Possible Cause	Remedy
1. The welding arc cannot be established.	A. The Primary supply voltage has not been switched ON. B. The Welding Power Source switch is switched OFF. C. Loose connections internally.	A. Switch ON the Primary supply voltage. B. Switch ON the Welding Power Source. C. Have an Accredited Thermal Arc Service Provider repair the connection.
2. The welding arc cannot be established when the Warning Indicator lights up continuously	The machines duty cycle has been exceeded	Wait for the Warning Indicator to extinguish before resuming welding
3. Maximum output welding current cannot be achieved with nominal Mains supply voltage.	Defective control circuit	Have an Accredited Thermal Arc Service Provider inspect then repair the welder.
4. Welding current reduces when welding.	Poor work lead connection to the work piece.	Ensure that the work lead has a positive electrical connection to the work piece.
5. Circuit breaker (or fuse) trips during welding.	The circuit breaker (or fuse) is under size.	The recommended circuit breaker (or fuse) size is 32 amp. An individual branch circuit capable of carrying 32 amperes and protected by fuses or circuit breaker is recommended for this application.
6. The welding arc cannot be established when Fault Indicator is flashing.	The input current to the main transformer has been exceeded.	Have an Accredited Thermal Arc Service Provider inspect then repair the welder.

---

**APPENDIX 1: OPTIONS AND ACCESSORIES**

---

Description	Part Number
26 TIG Torch with 12.5ft lead, finger remote control, 50mm dinse connection and accessory kit	W4013601
Foot Control, 8 pin amphenol, 15ft	600285
Slider Current Control with Torch Switch, 15ft, suits 1-1/8" dia. 26 TIG Torch Handle	10-4010
USA Graphics Auto-Darkening welding helmet, spare cover lens and operating manual	W4011700
Canadian Graphics Auto-Darkening welding helmet, spare cover lens and operating manual	W4011800
Claret Color Auto-Darkening welding helmet, spare cover lens and operating manual	W4011900
Black Graphics Auto-Darkening welding helmet, spare cover lens and operating manual	W4012000

## APPENDIX 2: REPLACEMENT PARTS

Item No	Description	Part No.	Reference Designator
1	Handle	W7003040	
2	Panel, Cover	W7003200	
3	Rectifier 1000V,50A	W7003010	
4	PCB, Control, 201 TS	W7003222	PCB2
5	Thermostat	W7003016	THC1, THC2
6	Resistor,4 ohm,60W	W7003055	R1
7	PCB, Power, 201 TS	W7003216	PCB1
8	Insulation Sheet	W7003214	
9	Points, HF Starter, 201 TS	W7003034	
10	Output Inductor Ferrite Core	W7003210	
11	Front Control PCB3	W7003218	PCB3
12	Front Panel	W7003205	
13	Front Panel Label	W7003219	
14	Rubber Boot	W7003064	
15	Knob, control, Red, 21 ODx6 ID	W7003079	
16	Connector, Gas Outlet, 161 STL-201 TS	W7003212	
17	Output Terminal, 50mm dinse	W7003020	
18	Socket, 8 Pin, cable, 161 STL-201 TS	W7003220	
19	Gas Solenoid	W7003033	
20	Current Sensor, 161-201TS	W7003076	Current Sensor
21	Base Panel	W7003209	
22	Fan,24V DC	W7003090	
23	Rear Panel	W7003201	
24	Connector, Gas Inlet, 161 STL-201 TS	W7003215	
25	ON/OFF Switch	W7003053	SW1
26	PCB, Remote, 161 STL-201 TS	W7003221	PCB4

**WARNING**

*There are extremely dangerous voltages and power levels present inside this product. Do not attempt to repair unless you are an Accredited Thermal Arc Service Agent and you have had training in power measurements and troubleshooting techniques. If major complex subassemblies are faulty, then the Welding Power Source must be returned to an Accredited Thermal Arc Service Agent for repair.*

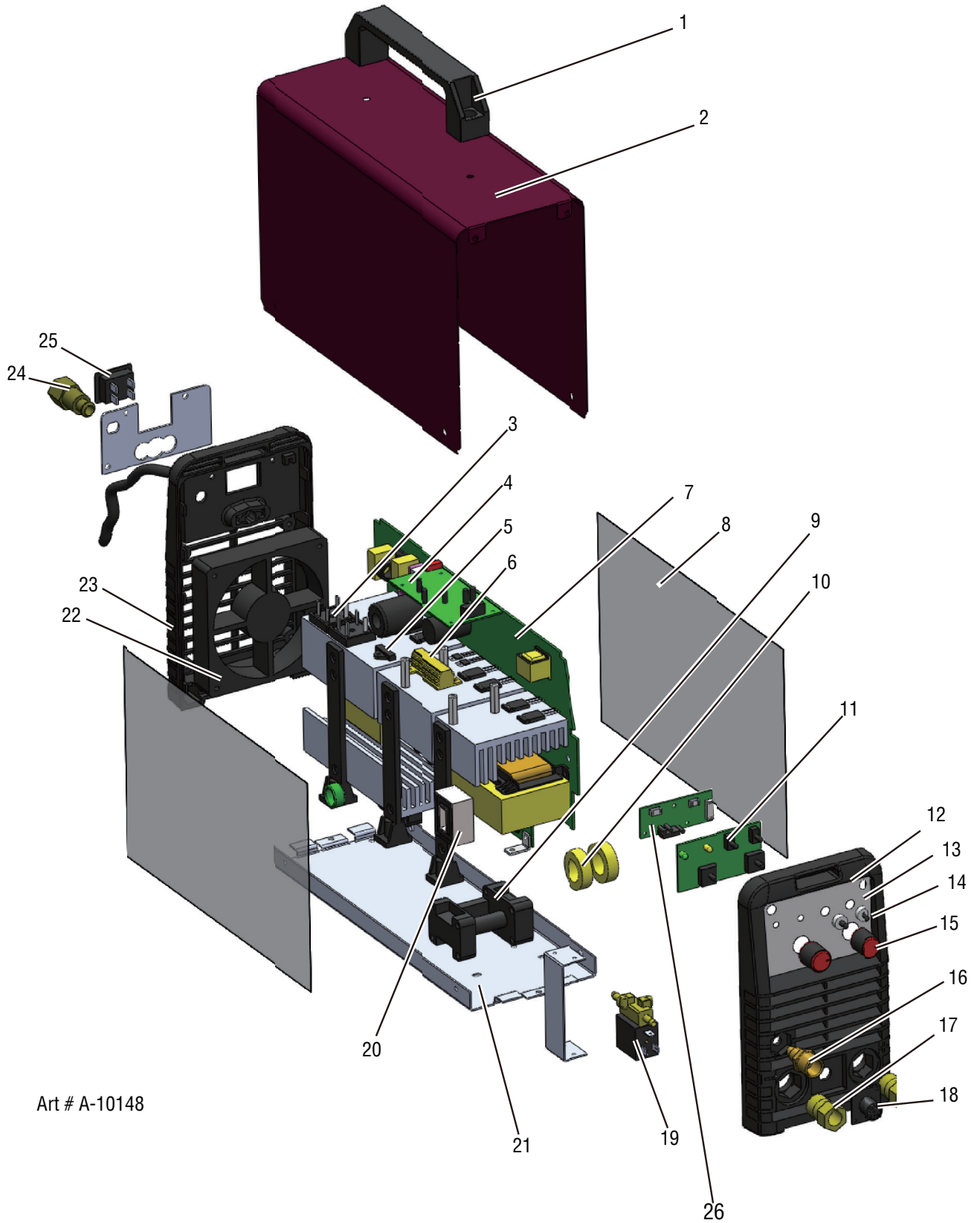

Art # A-10148

APPENDIX 3: 201 TS SYSTEM SCHEMATIC

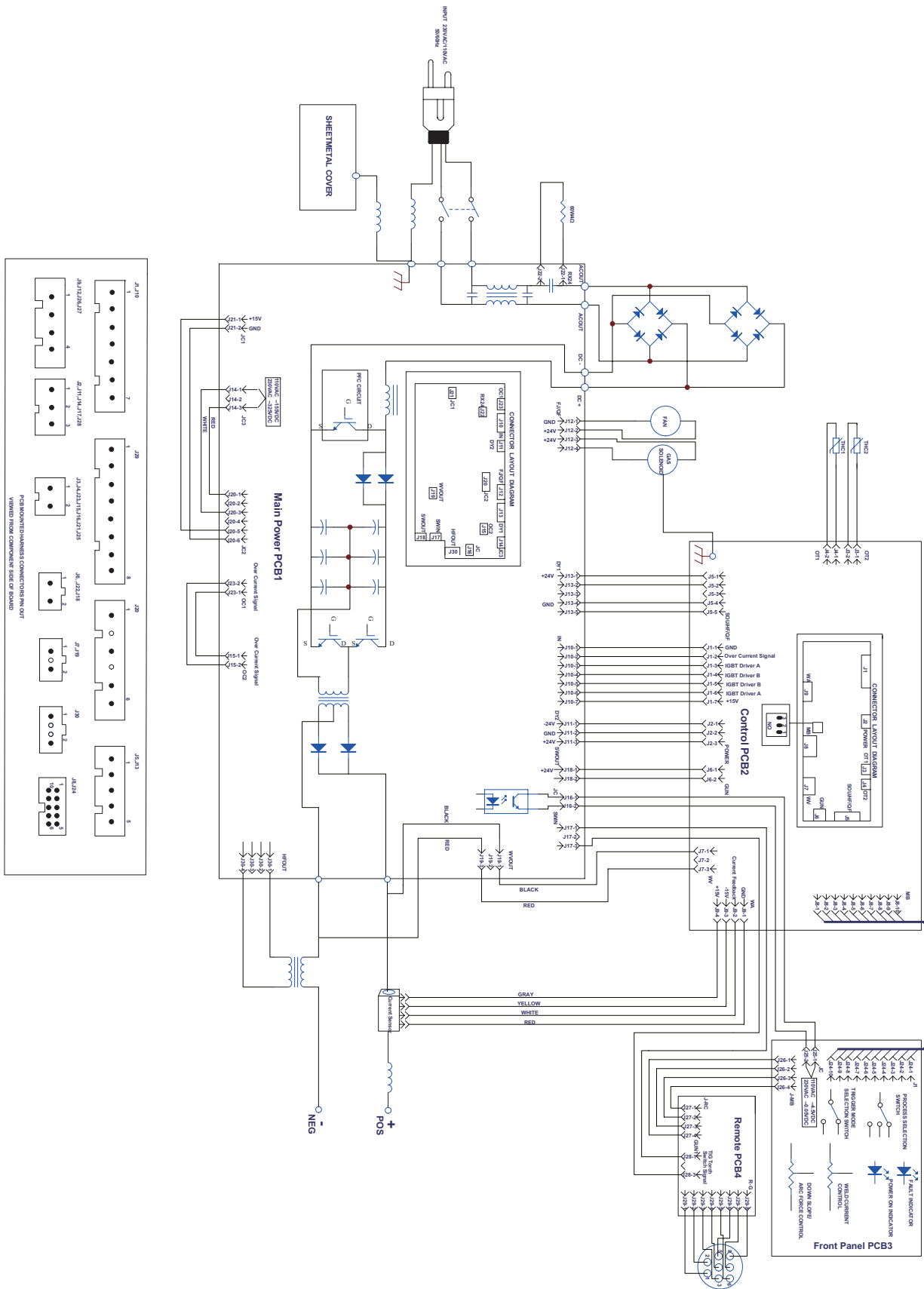

Art # A-10149\_AB

## LIMITED WARRANTY & WARRANTY SCHEDULE

---

In accordance with the warranty periods stated below, Thermadyne guarantees the proposed product to be free from defects in material or workmanship when operated in accordance with the written instructions as defined in this operating manual.

Thermadyne welding products are manufactured for use by commercial and industrial users and trained personnel with experience in the use and maintenance of electrical welding and cutting equipment.

Thermadyne will repair or replace, at its discretion, any warranted parts or components that fail due to defects in material or workmanship within the warranty period. The warranty period begins on the date of sale to the end user.

<i>Welding Equipment - Limited Warranty Period</i>	
<i>Product</i>	<i>Period</i>
<i>Thermal Arc 201TS</i>	<i>2 Years</i>
<i>TIG torch, electrode holder and work lead</i>	<i>30 Days</i>

If warranty is being sought Thermadyne must be notified in writing within 30 days of the failure and at such time we will make arrangements to fulfil the warranty claim. Please contact your Thermadyne product supplier for the warranty repair procedure.

### **Thermadyne warranty will not apply to:**

- Equipment that has been modified by any other party other than Thermadyne's own service personnel or with prior written consent obtained from Thermadyne service department (UK).
- Equipment that has been used beyond the specifications established in the operating manual.
- Installation not in accordance with the installation/operating manual.
- Any product that has been subjected to abuse, misuse, negligence, accident, improper care and/or maintenance including lack of lubrication, maintenance and protection, will be refused warranty.
- Failure to clean and maintain the machine as set forth in the operating, installation or service manual.

Within this operating manual are details regarding the maintenance necessary to ensure trouble free operation. This manual also offers basic troubleshooting, operational and technical details including application usage.

Using this manual correctly will ensure the quickest time possible for resolving any technical questions, application issues or defects with your Thermadyne product.

You may also wish to visit our web site [www.thermadyne.com](http://www.thermadyne.com) select your product class and then select literature. Here you will find documentation including:

- Operator manuals
- Service manuals
- Product guides

Alternatively please contact your Thermadyne distributor and speak with a technical representative.

---

### *NOTE*

*Warranty repairs must be performed by either a Thermadyne Service Centre, a Thermadyne distributor or an Authorised Service Agent approved by the Company.*

**Customer Care UK: +44 (0)1257 261 755 / Fax: +44 (0)1257 224 800**  
**Customer Care Italy +39 02 36546801 / Fax: +39 02 36546480**  
**[www.thermadyne.com](http://www.thermadyne.com)**

***A Global Cutting & Welding Market Leader™***



**WORLD HEADQUARTERS:** 16052 Swingley Ridge Road, Suite 300 • St. Louis, Missouri 63017 U.S.A.

**THE AMERICAS**

**Denton, TX USA**  
**U.S. Customer Care**  
Ph: 1-800-426-1888 (tollfree)  
Fax: 1-800-535-0557 (tollfree)  
**International Customer Care**  
Ph: 1-940-381-1212  
Fax: 1-940-483-8178

**Miami, FL USA**  
**Sales Office, Latin America**  
Ph: 1-954-727-8371  
Fax: 1-954-727-8376

**Oakville, Ontario, Canada**  
**Canada Customer Care**  
Ph: 1-905-827-4515  
Fax: 1-800-588-1714 (tollfree)

**EUROPE**

**Chorley, United Kingdom**  
**Customer Care**  
Ph: +44 1257-261755  
Fax: +44 1257-224800

**Milan, Italy**  
**Customer Care**  
Ph: +39 0236546801  
Fax: +39 0236546840

**ASIA/PACIFIC**

**Cikarang, Indonesia**  
**Customer Care**  
Ph: 6221-8990-6095  
Fax: 6221-8990-6096

**Rawang, Malaysia**  
**Customer Care**  
Ph: +603 6092-2988  
Fax: +603 6092-1085

**Melbourne, Australia**  
**Australia Customer Care**  
Ph: 1300-654-674 (tollfree)  
Ph: 61-3-9474-7400  
Fax: 61-3-9474-7391  
**International**  
Ph: 61-3-9474-7508  
Fax: 61-3-9474-7488

**Shanghai, China**  
**Sales Office**  
Ph: +86 21-64072626  
Fax: +86 21-64483032

**Singapore**  
**Sales Office**  
Ph: +65 6832-8066  
Fax: +65 6763-5812